

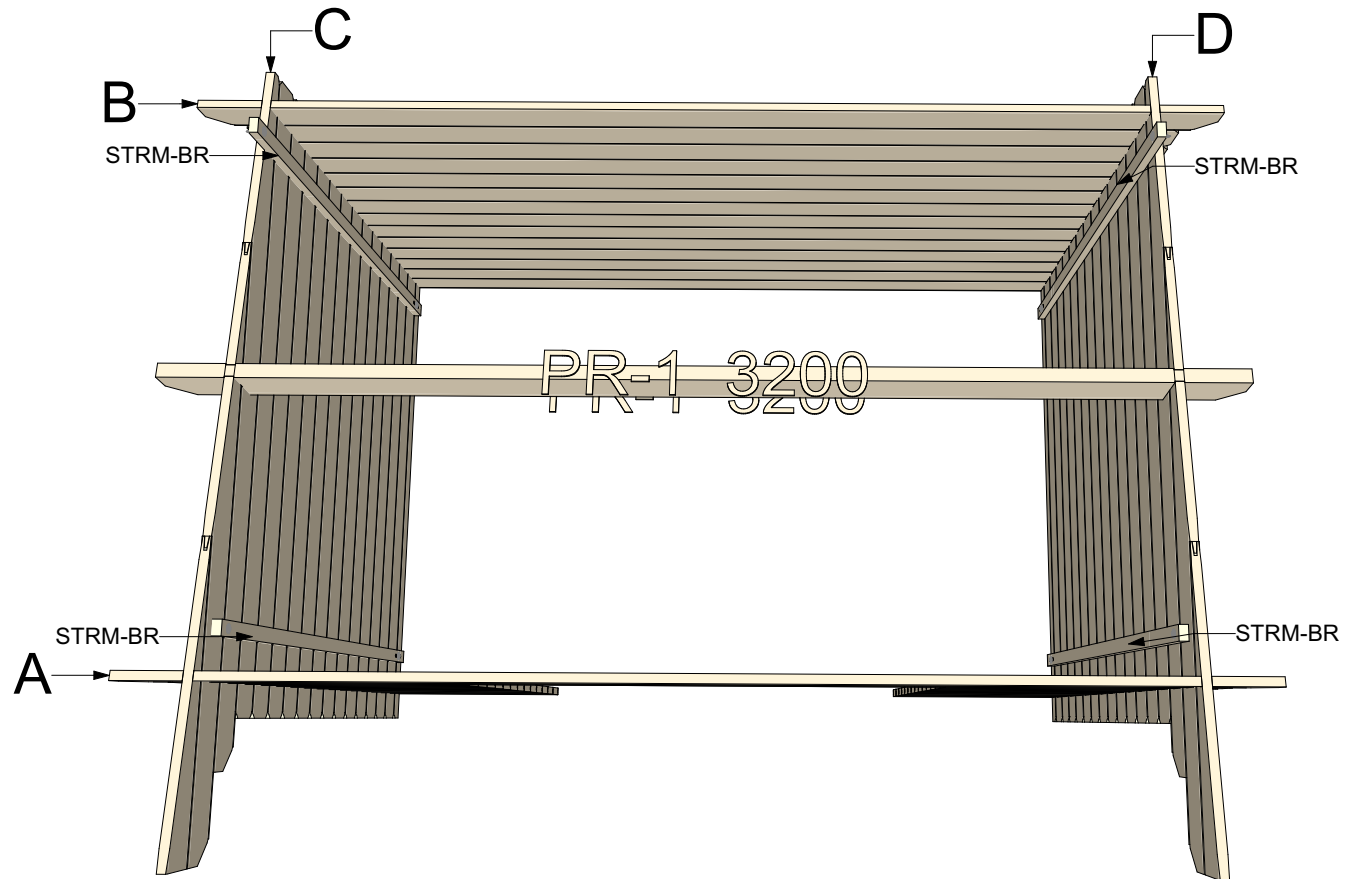

28 Edith 3x2

Walls and purlins positions



Thickness:	Project name:	Project ID:	Year:	Page:
28	Edith	3x2	2024	2

Floor bearers

1:40

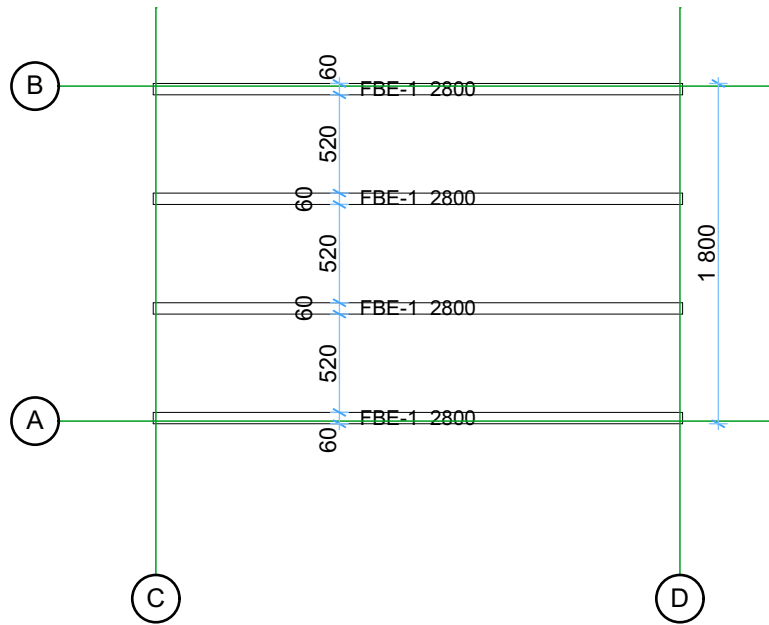

Floor boards

1:40

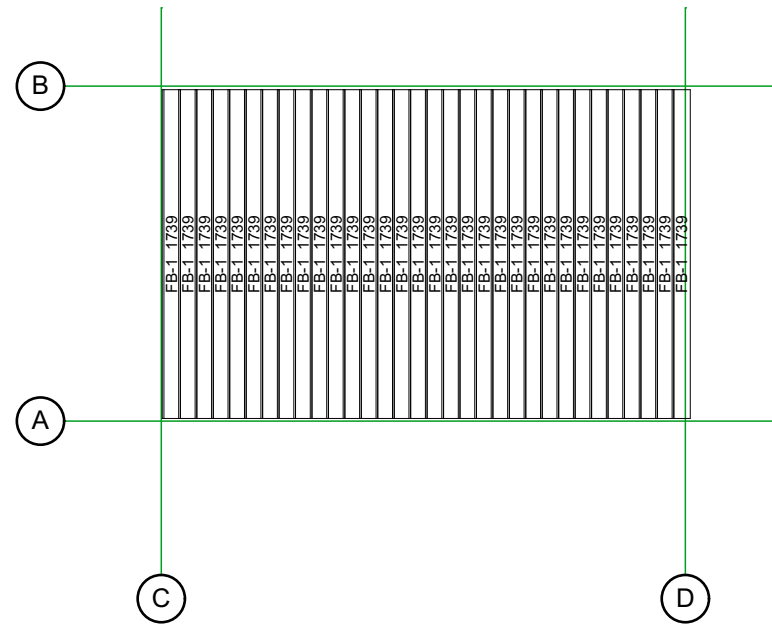

Thickness:	Project name:	Project ID:	Year:	Page:
28	Edith	3x2	2024	3

Ground floor plan

1:40

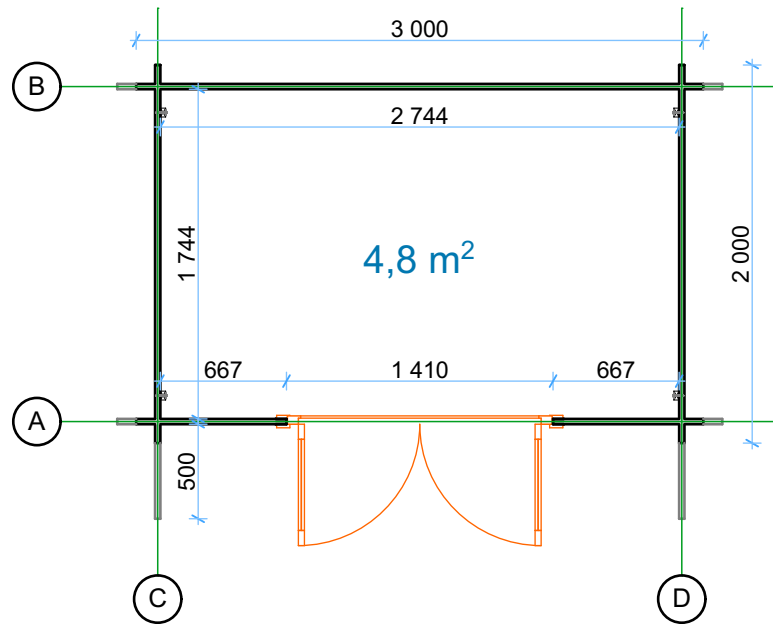

Roof boards

1:40

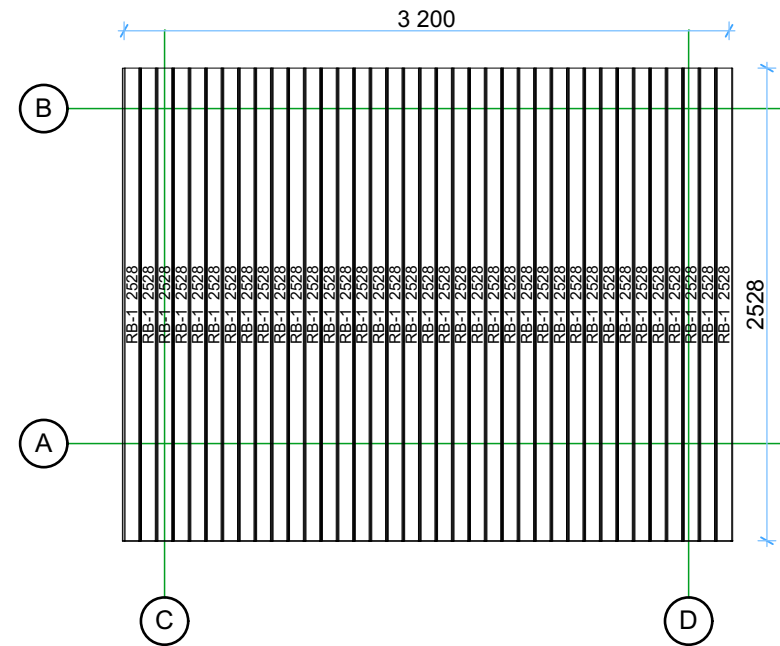

Thickness:	Project name:	Project ID:	Year:	Page:
28	Edith	3x2	2024	4

Wall A

1:40

Wall C

1:40

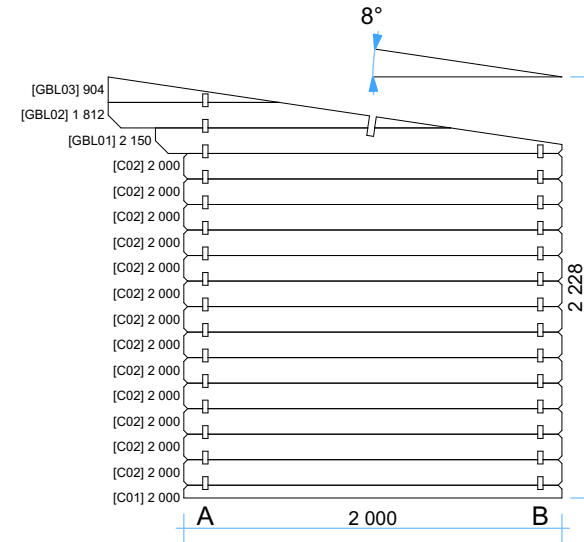
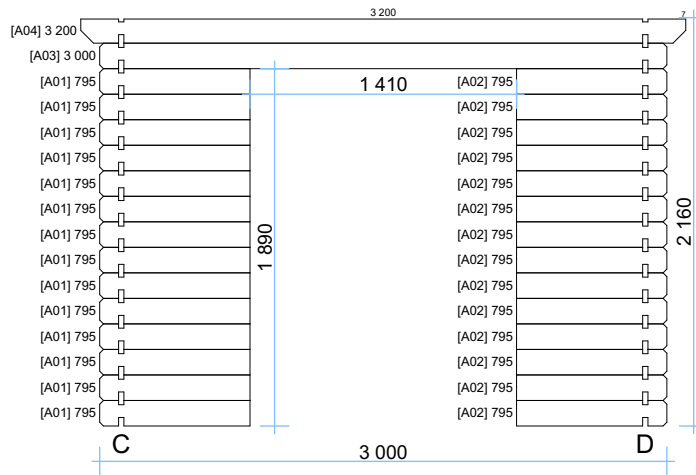

Wall B

1:40

Wall D

1:40

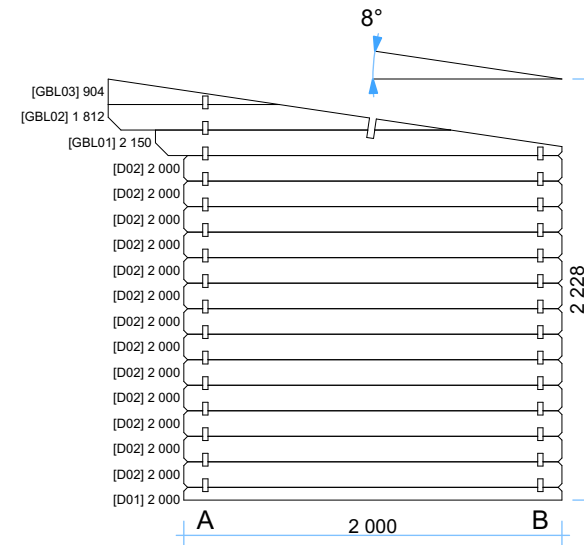

Thickness:	Project name:	Project ID:	Year:	Page:
28	Edith	3x2	2024	5

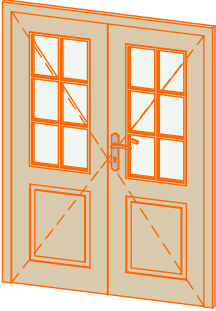
Windows and doors list							
Barcode	Type-quality	Wall Thickness	W x H Size	Orientation	Glazing	Quantity	3D Axonometry
185140-2	Door - Economy	28	1 400×1 850	R	50% glass, single glazed	1	

Thickness:	Project name:	Project ID:	Year:	Page:
28	Edith	3x2	2024	6