

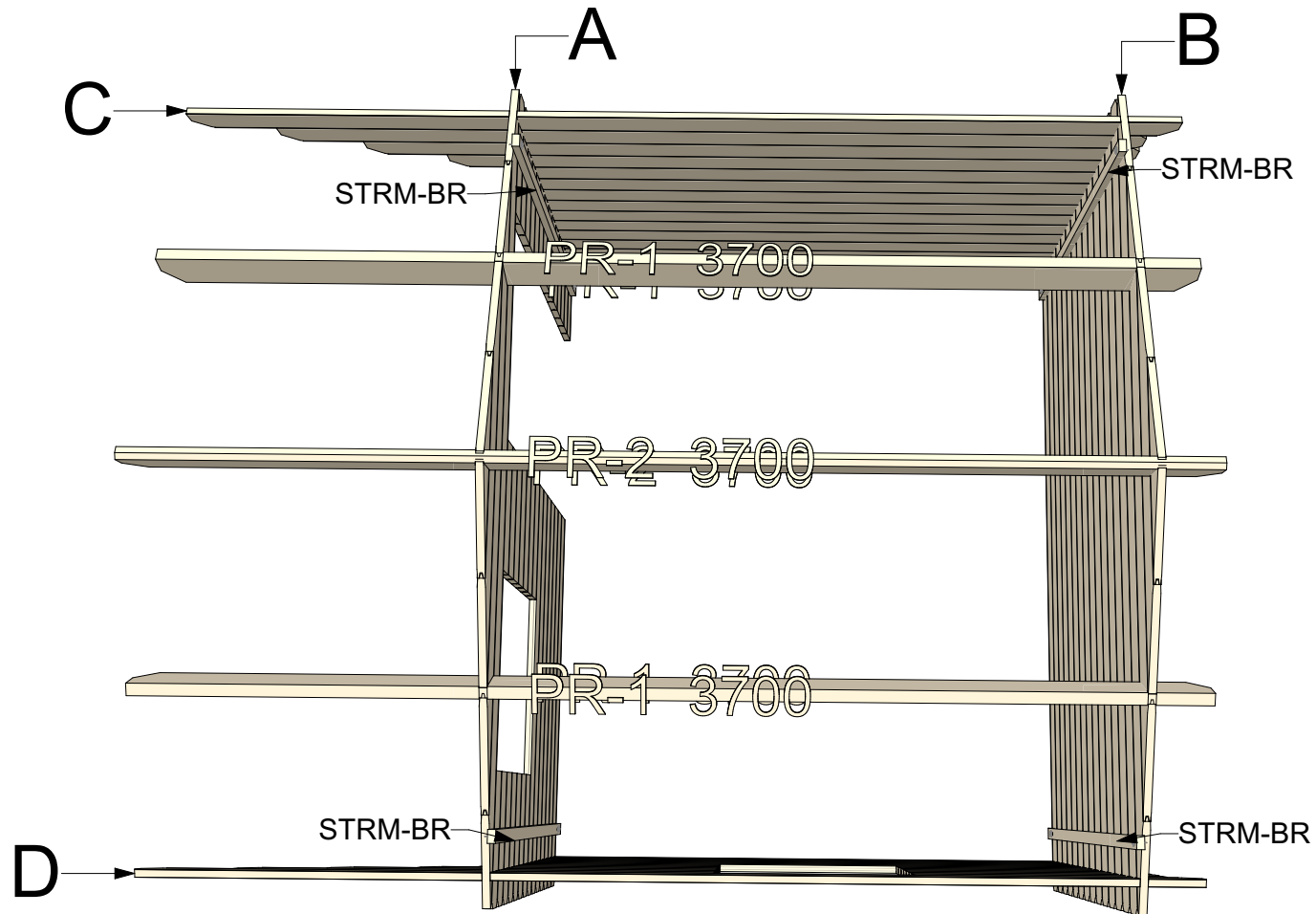

28 Modena 3x2,5

Walls and purlins positions



Thickness:	Project name:	Project ID:	Year:	Page:
28	Modena	3x2,5	2024	2

Floor bearers

1:50

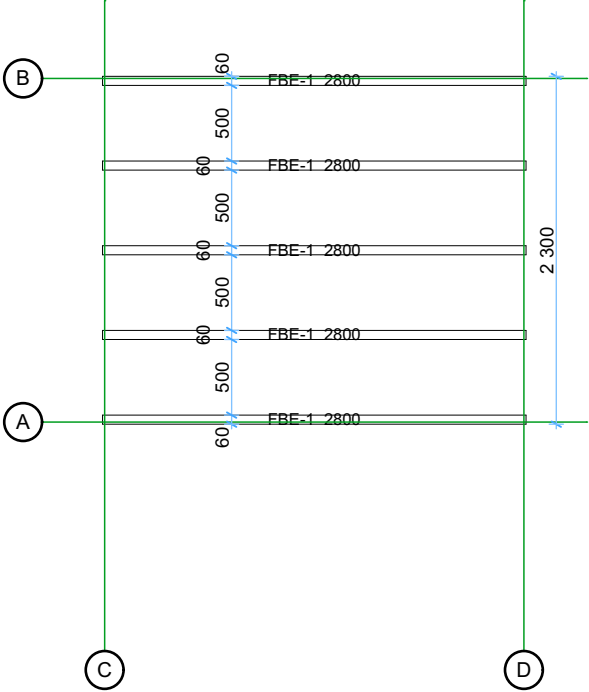

Floor boards

1:50

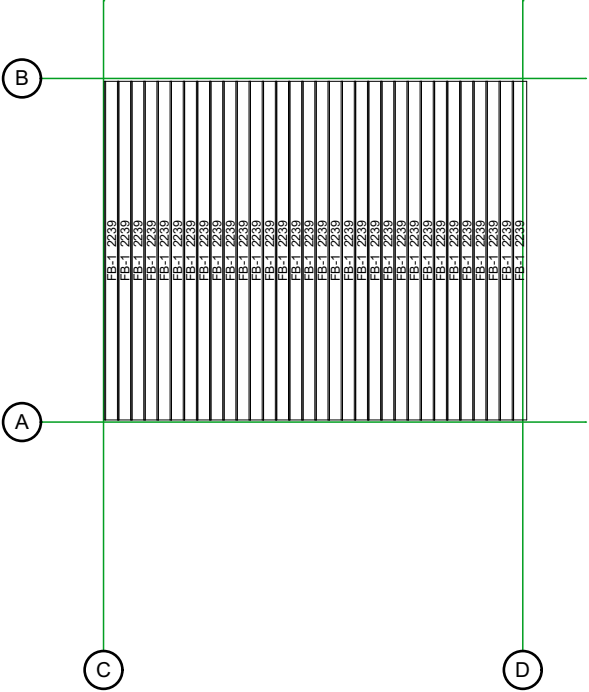

Thickness:	Project name:	Project ID:	Year:	Page:
28	Modena	3x2,5	2024	3

Ground floor plan

1:50

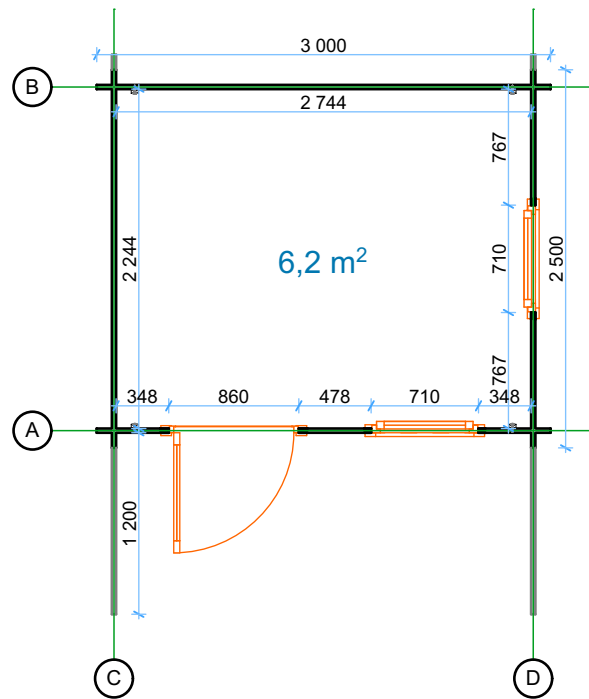

Roof boards

1:50

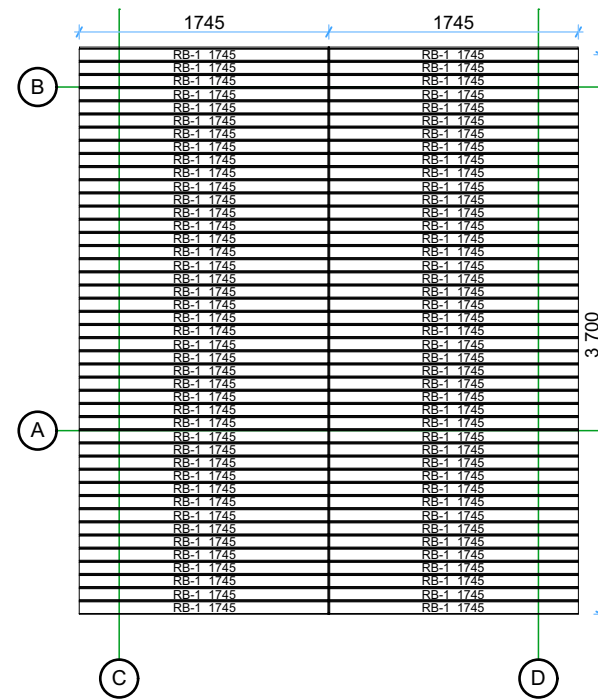

Thickness:	Project name:	Project ID:	Year:	Page:
28	Modena	3x2,5	2024	4

Wall A

1:40 Wall C

1:40

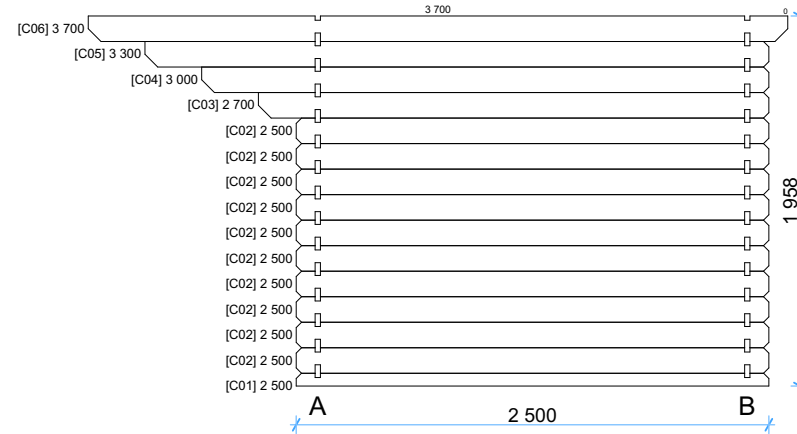
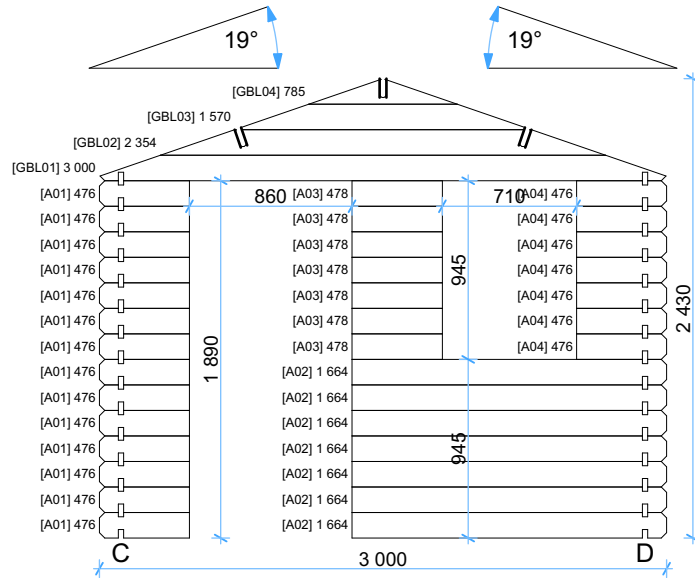



Wall B

1:40 Wall D

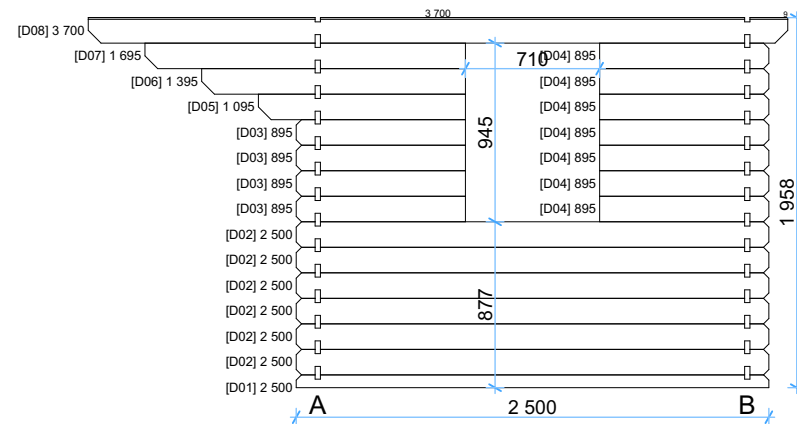
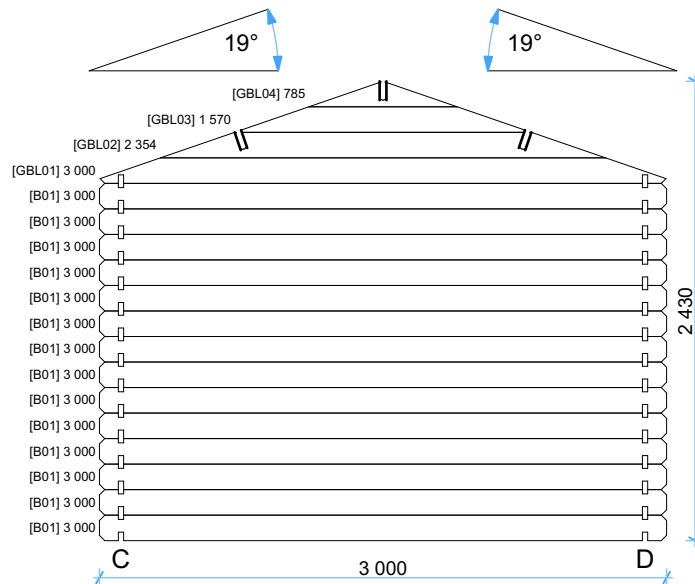
1:40

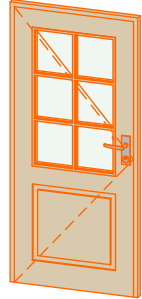

Thickness:	Project name:	Project ID:	Year:	Page:
28	Modena	3x2,5	2024	5

Windows and doors list							
Barcode	Type-quality	Wall Thickness	W x H Size	Orientation	Glazing	Quantity	3D Axonometry
S18585-2	Door - Economy	28	850×1 850	L	50% glass, single glazed	1	
S9270	Window - Economy	28	700×920	L	Single glazed	2	

Thickness:	Project name:	Project ID:	Year:	Page:
28	Modena	3x2,5	2024	6