

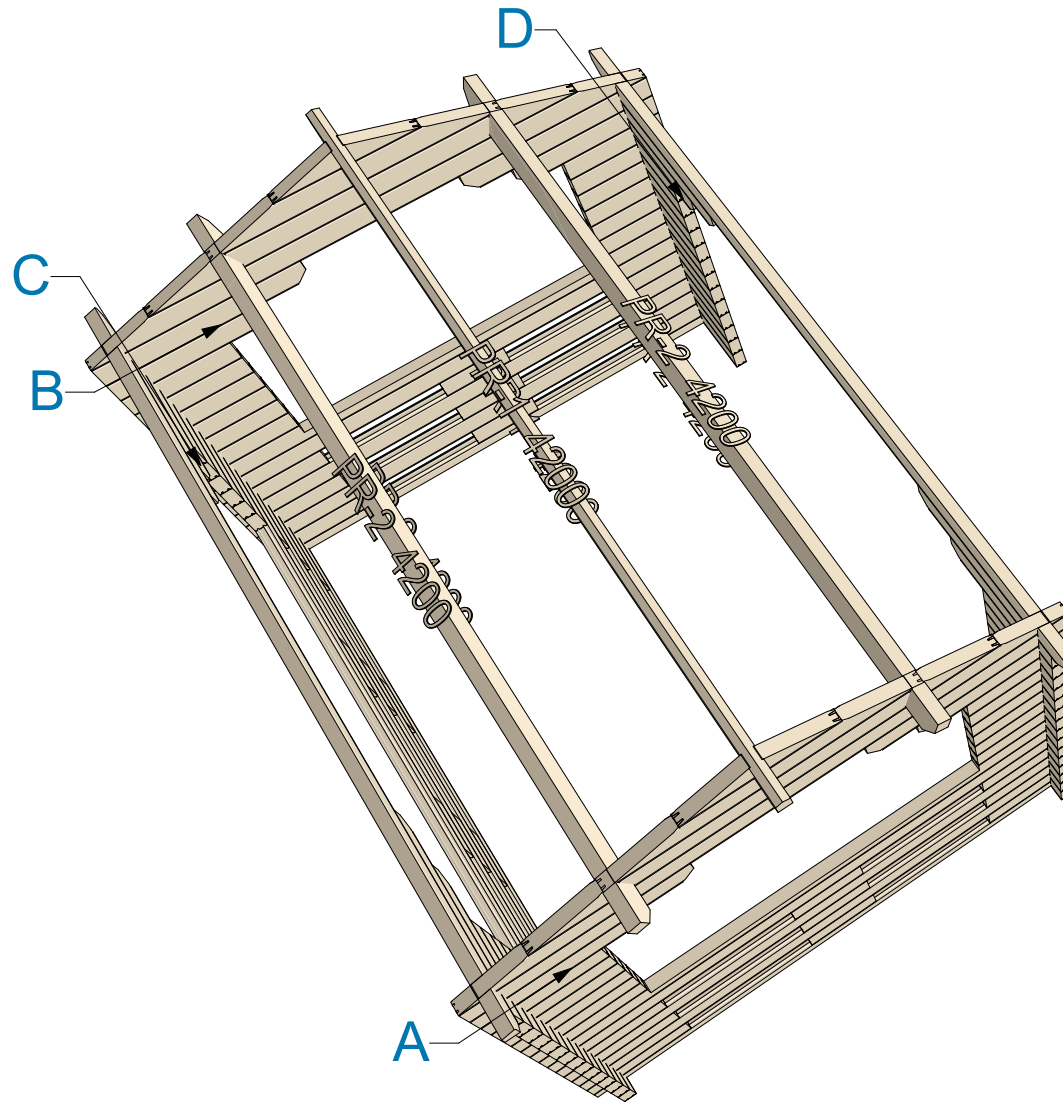

**68 Pergola-Luna**

## Walls and purlins positions



Thickness:	Project name:	Project ID:	Year:	Page:
68	Pergola-Luna		2024	2

Floor bearer

1:40

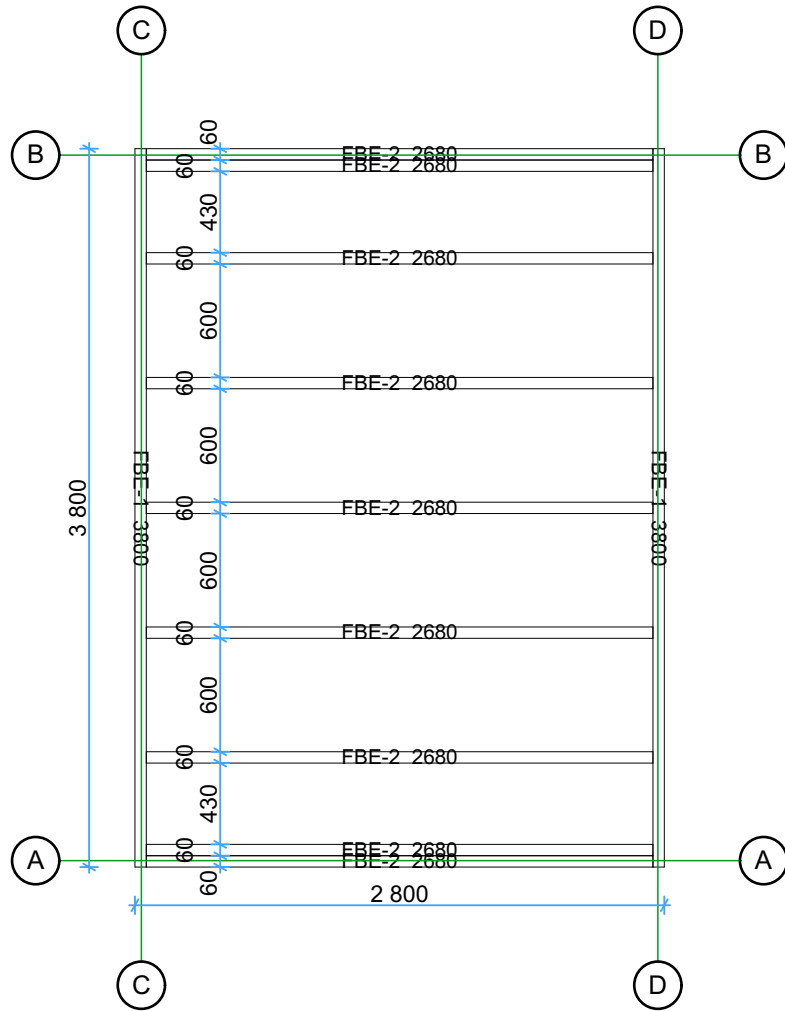

Floor boards

1:40

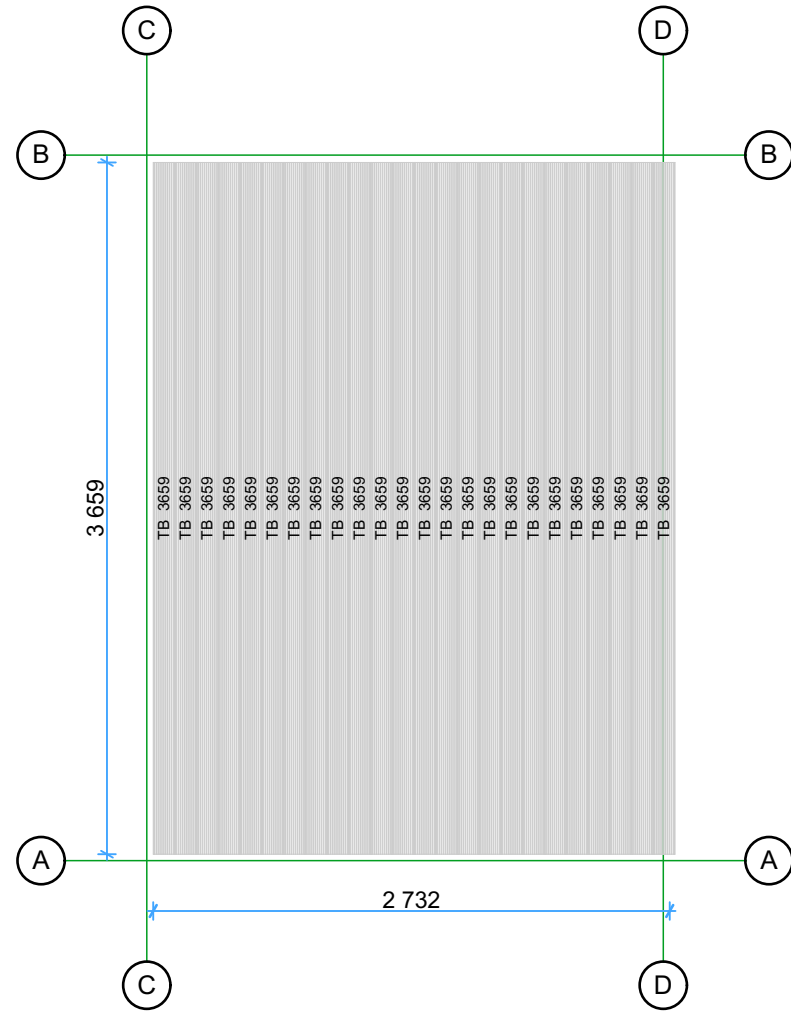

Thickness:	Project name:	Project ID:	Year:	Page:
68	Pergola-Luna		2024	3

Ground Floor plan

1:40

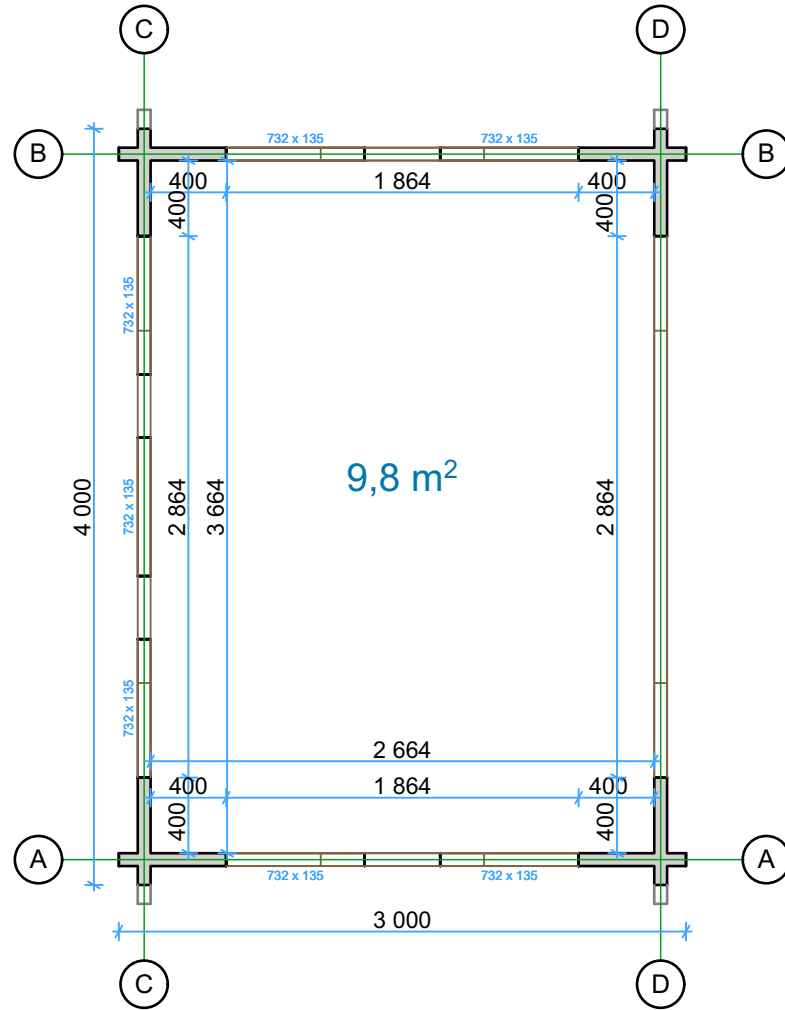

Roof boards

1:40

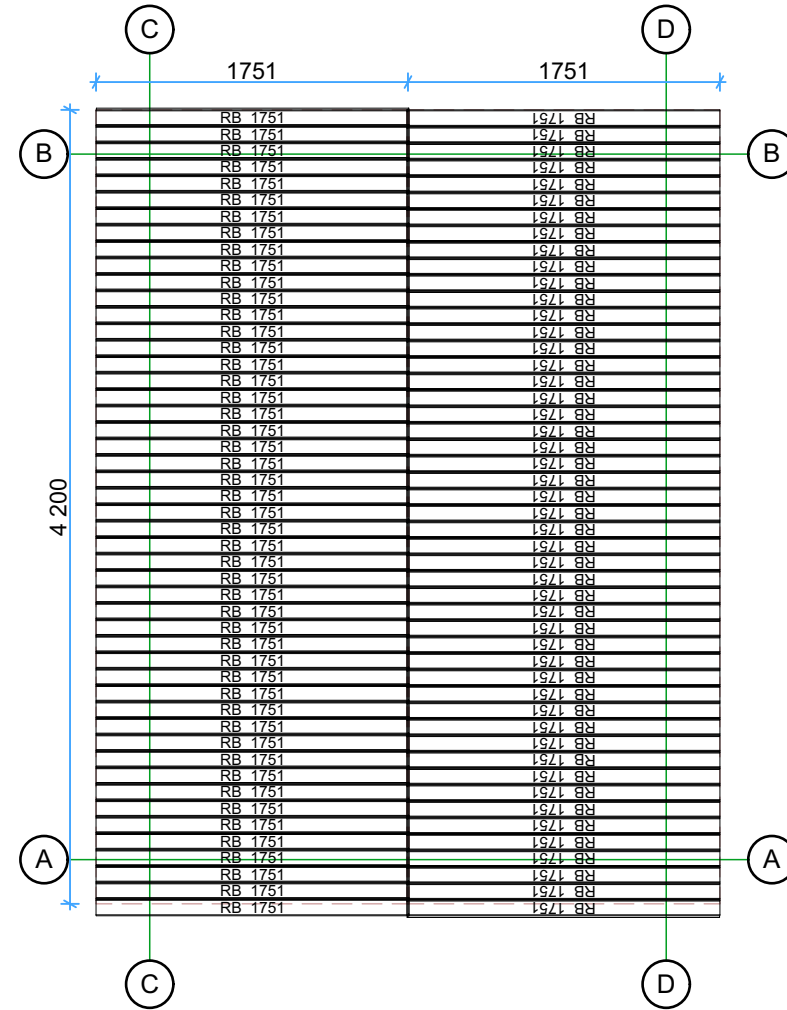

Thickness:	Project name:	Project ID:	Year:	Page:
68	Pergola-Luna		2024	4

# Wall A

1:40

# Wall B

1:40

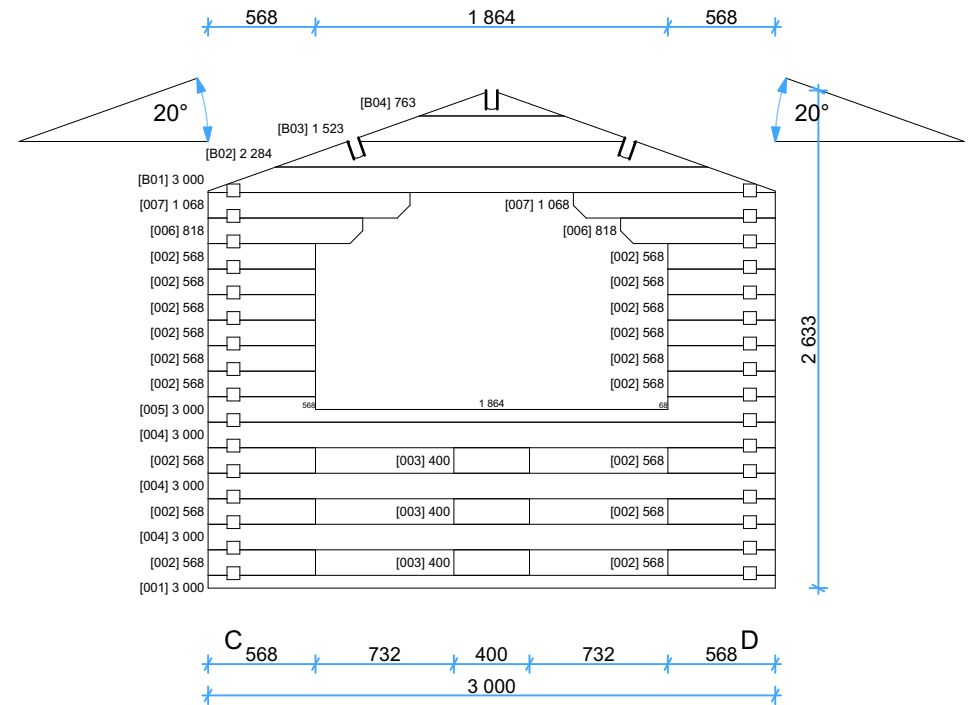
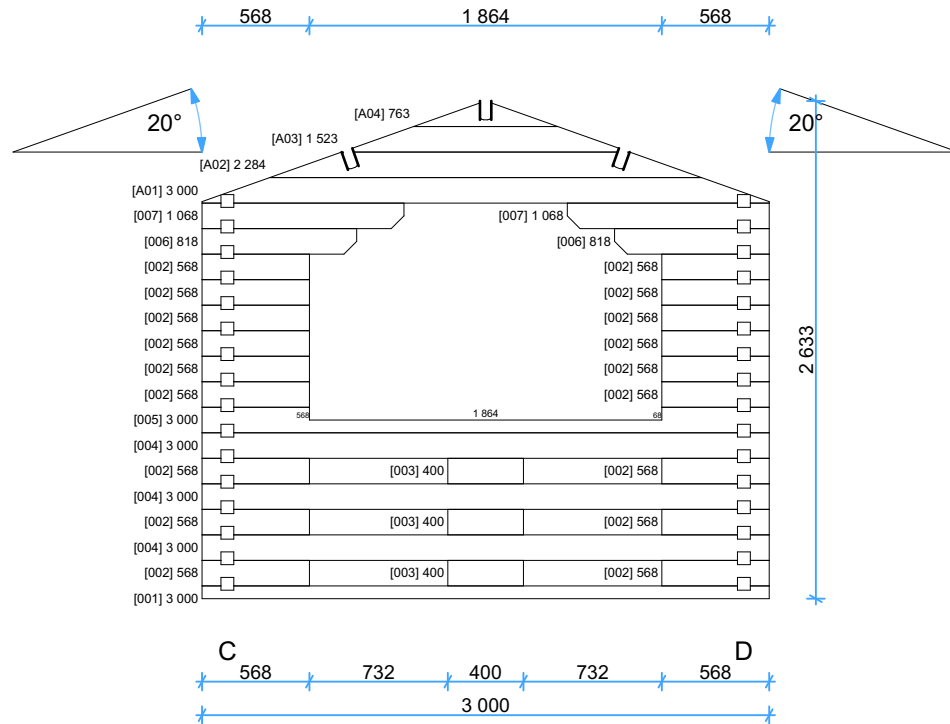

Thickness:	Project name:	Project ID:	Year:	Page:
68	Pergola-Luna		2024	5

# Wall C

1:40

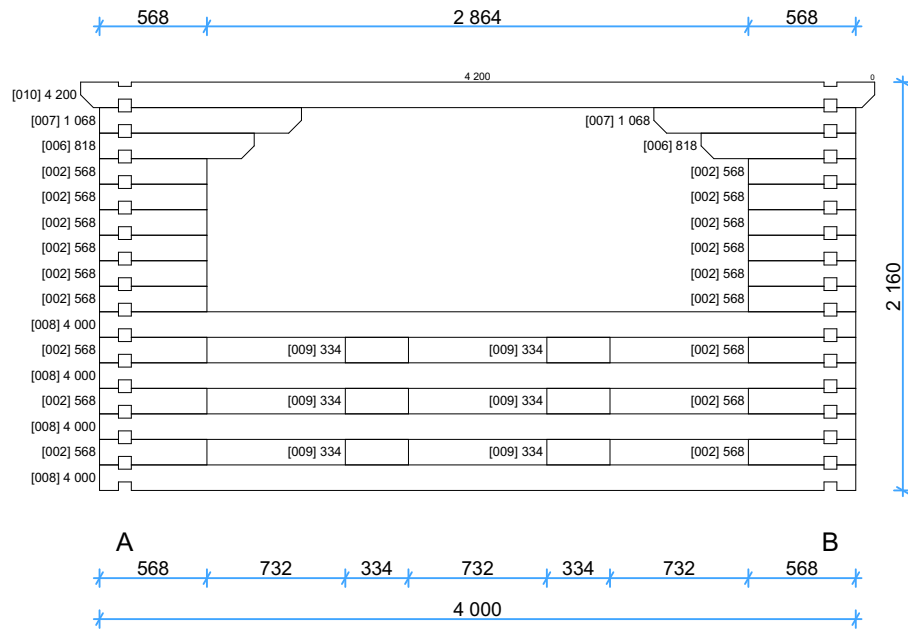

# Wall D

1:40

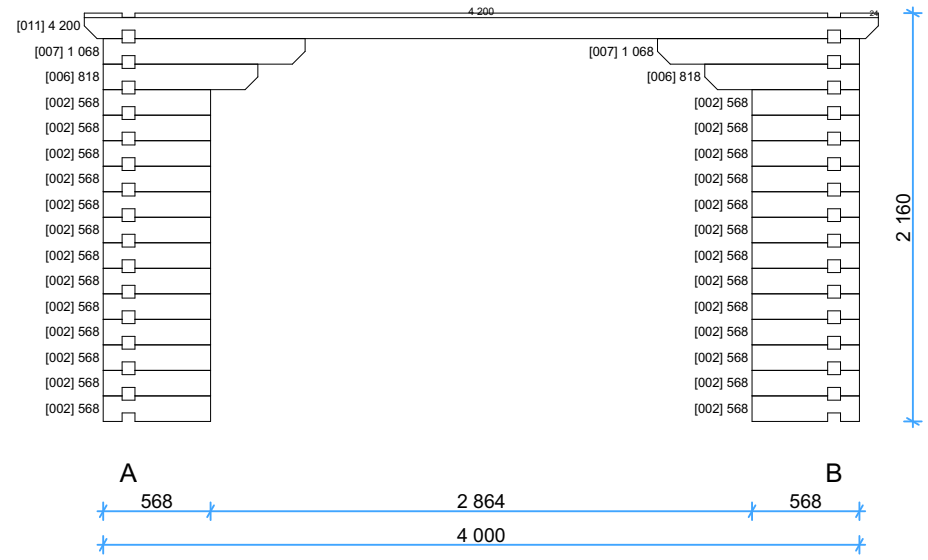

Thickness:	Project name:	Project ID:	Year:	Page:
68	Pergola-Luna		2024	6