

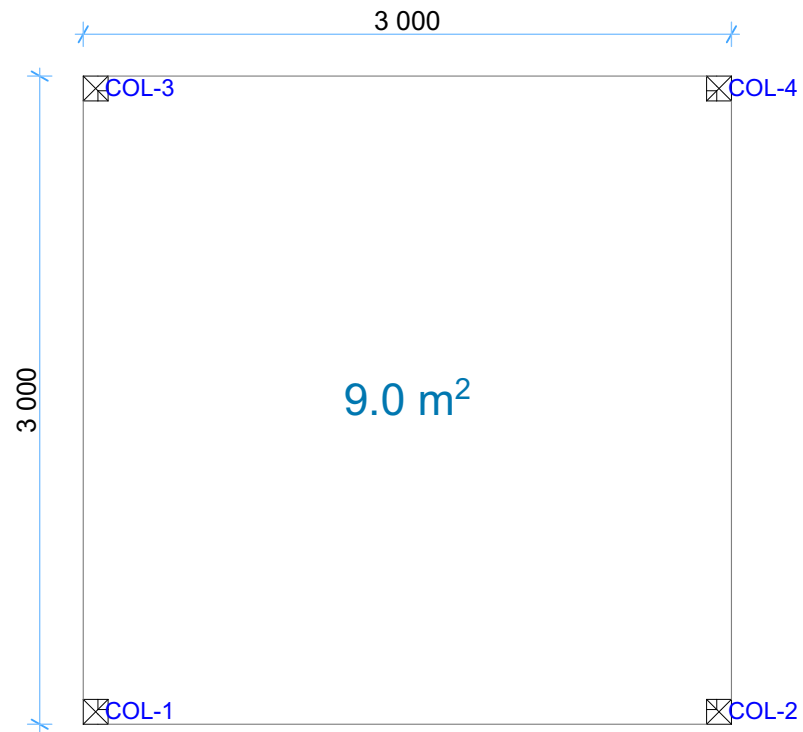

**Pergola-Rose**

Ground floor plan

1:35



Roof boards

1:35

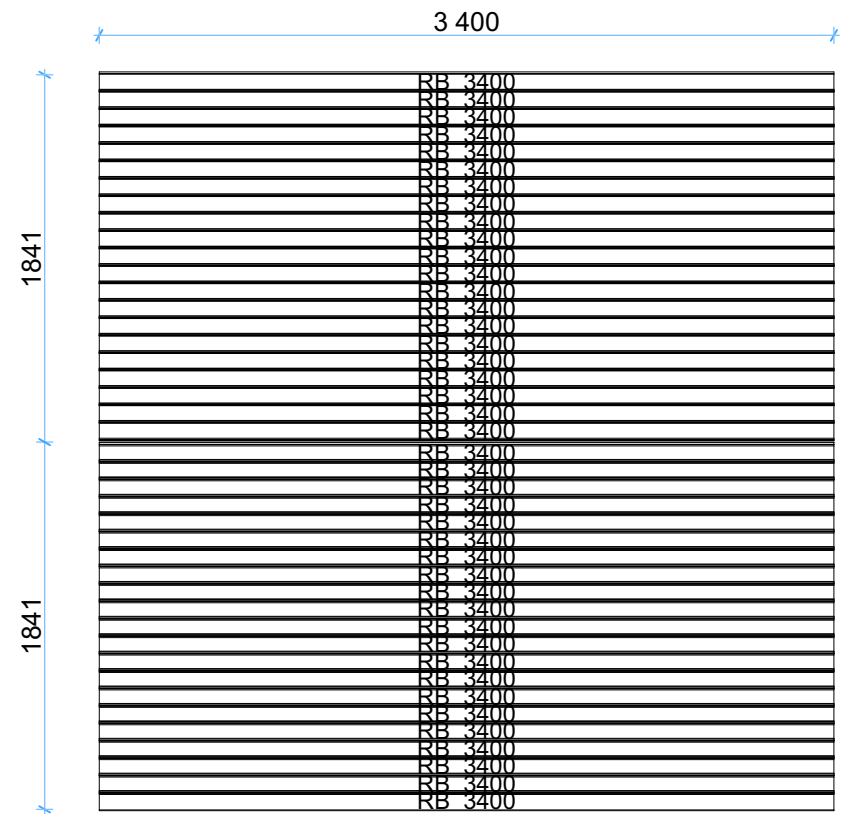

Thickness:	Project name:	Project ID:	Year:	Page:
	Pergola-Rose		2023	2

Beams, columns and purlins position

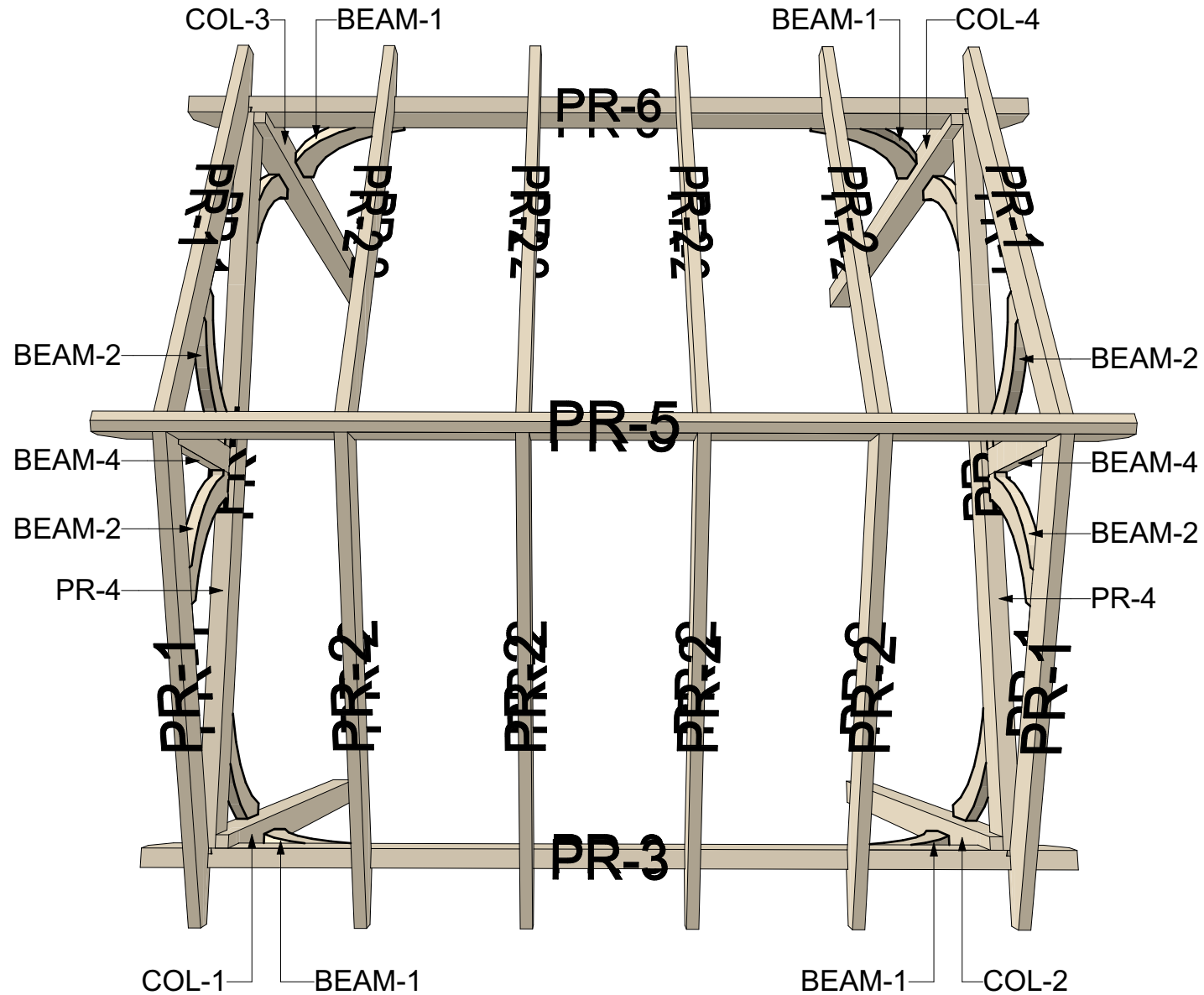

Thickness:	Project name:	Project ID:	Year:	Page:
	Pergola-Rose		2023	3

Back Elevation

1:45

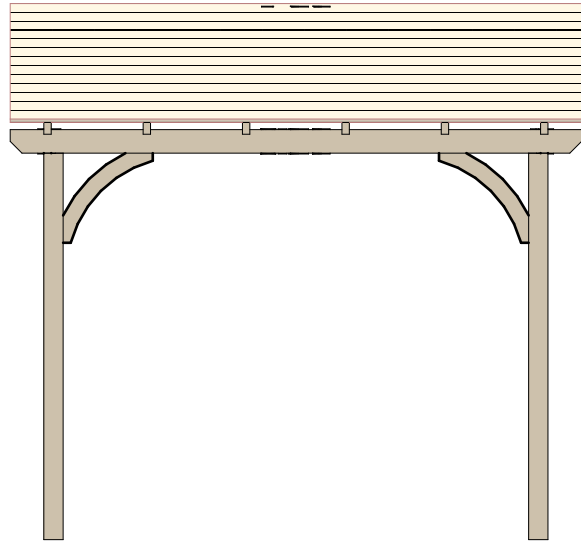

Front Elevation

1:45

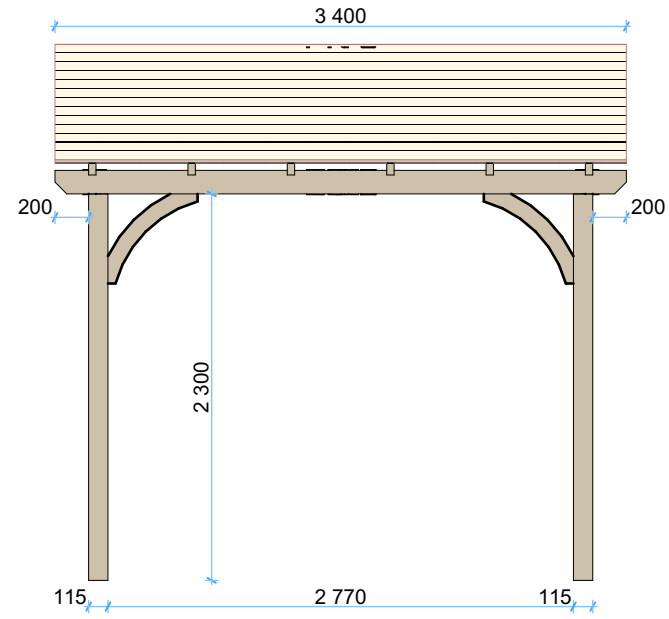

Left Elevation

1:45

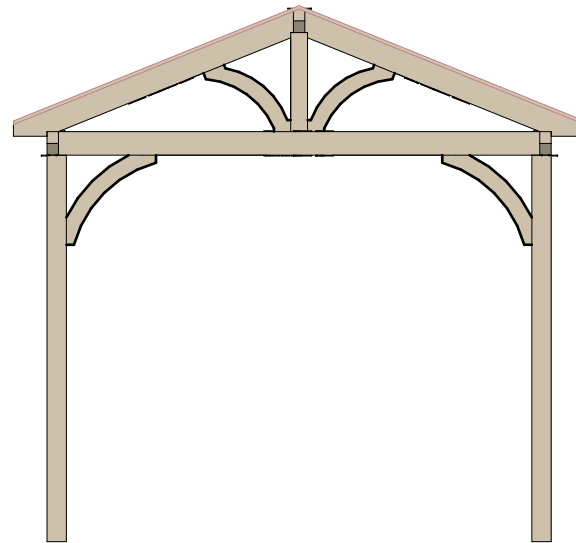

Right Elevation

1:45

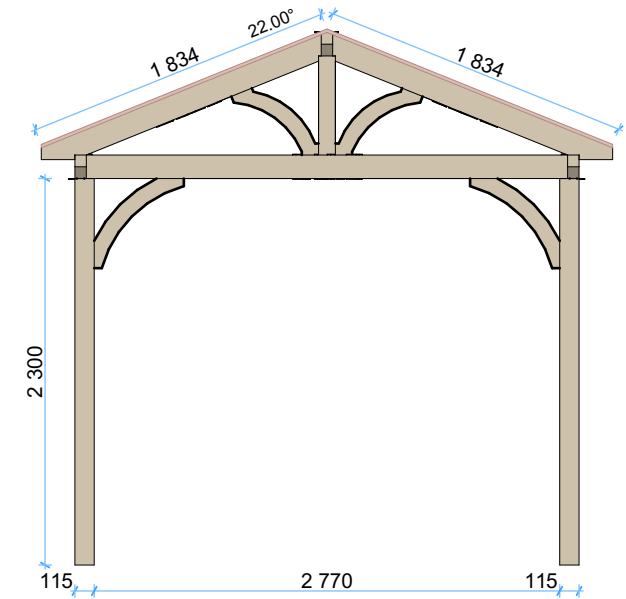

Thickness:	Project name:	Project ID:	Year:	Page:
	Pergola-Rose		2023	4