

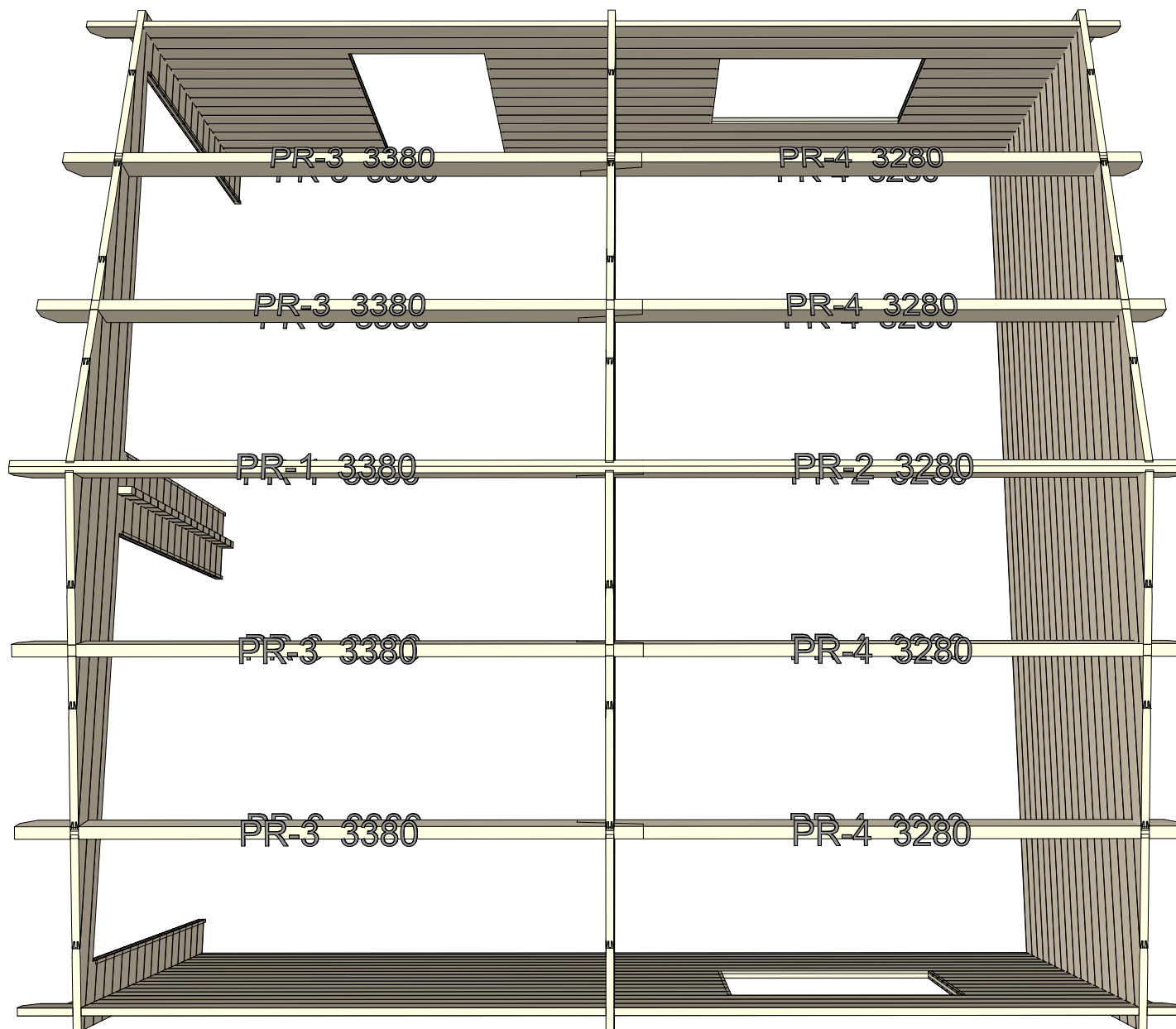

44 Garage 6x6 v.2

Walls and purlins positions



Thickness:	Project name:	Project ID:	Year:	Page:
44	Garage 6x6	v.2	2022	2

Floor bearers

1:50

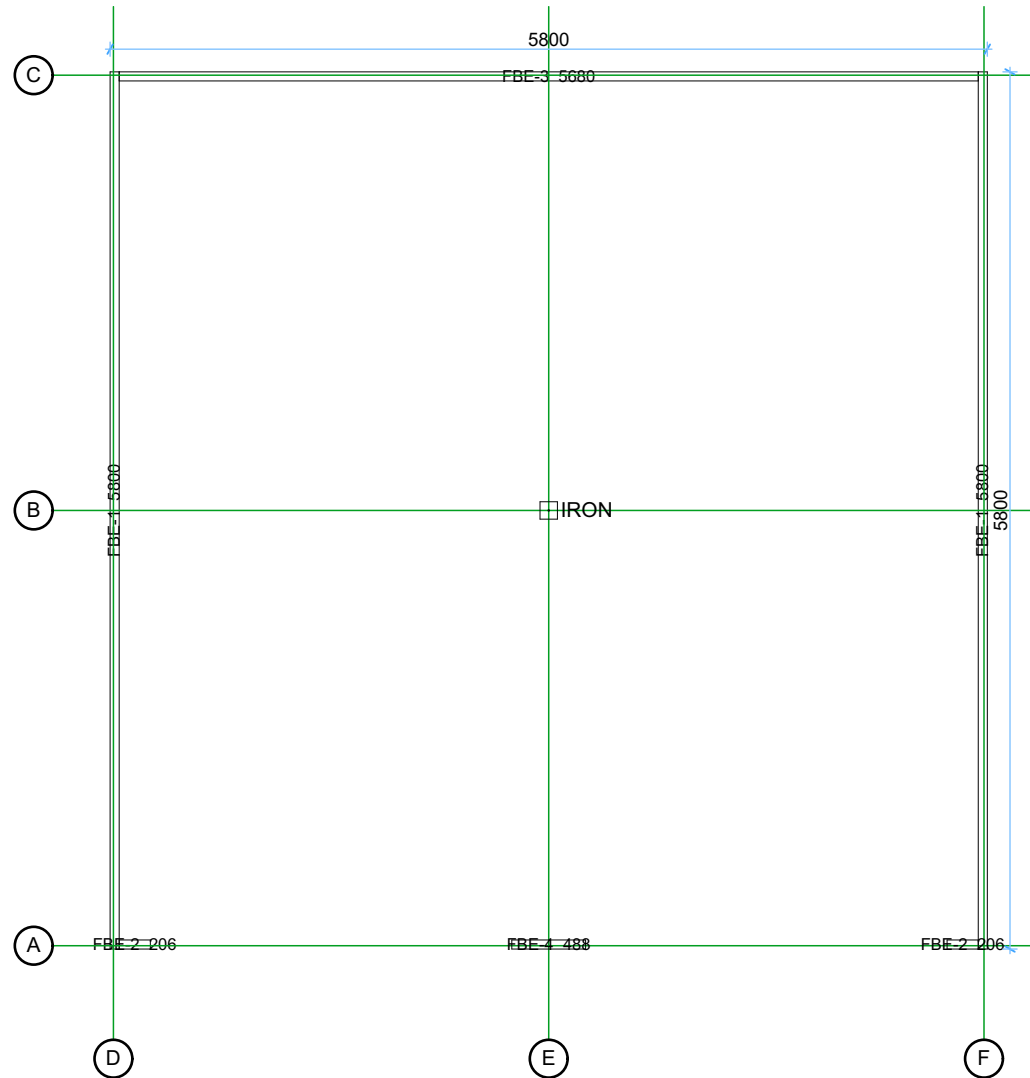

Thickness:	Project name:	Project ID:	Year:	Page:
44	Garage 6x6	v.2	2022	3

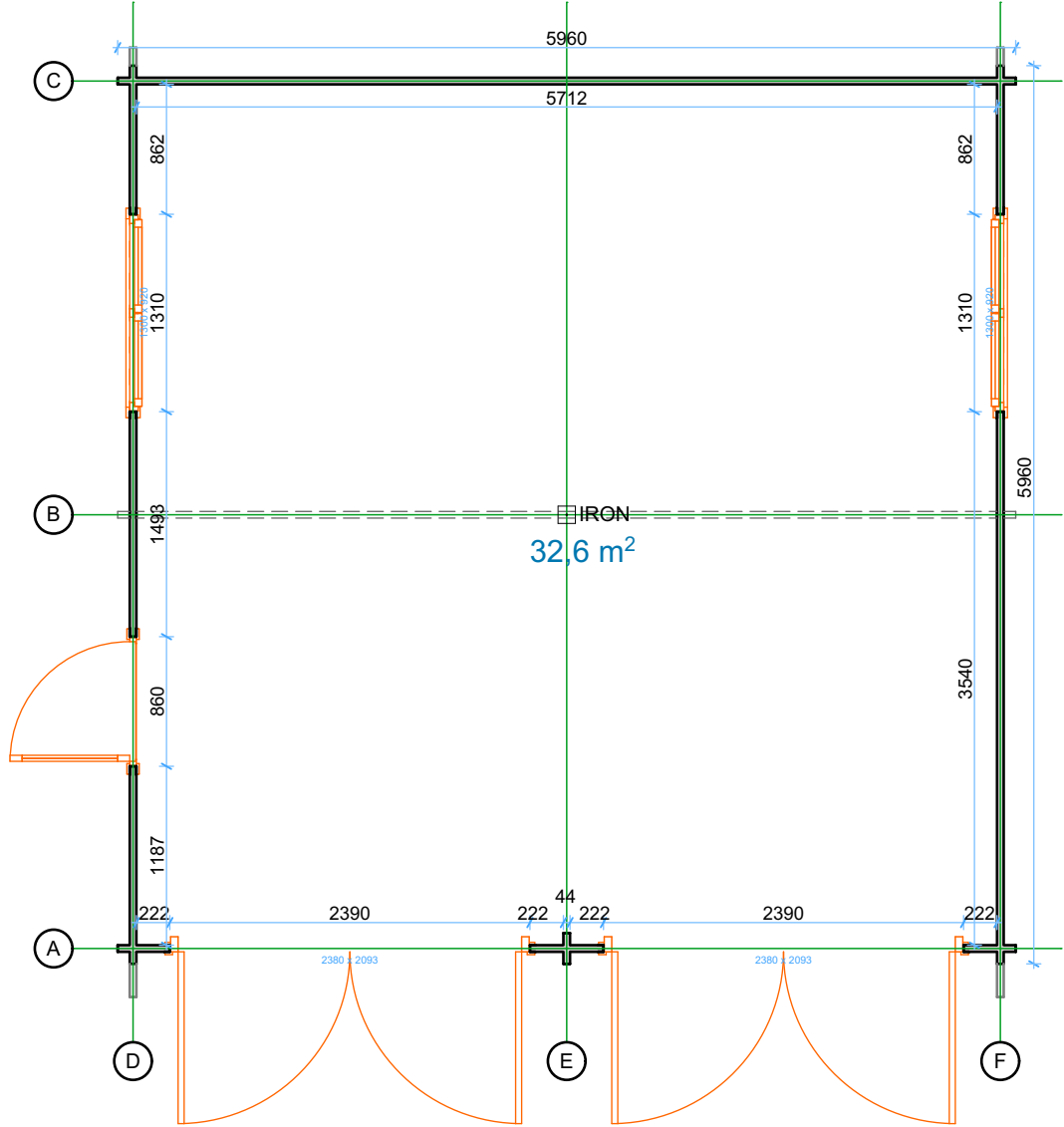

Thickness:	Project name:	Project ID:	Year:	Page:
44	Garage 6x6	v.2	2022	4

Roof boards

1:50

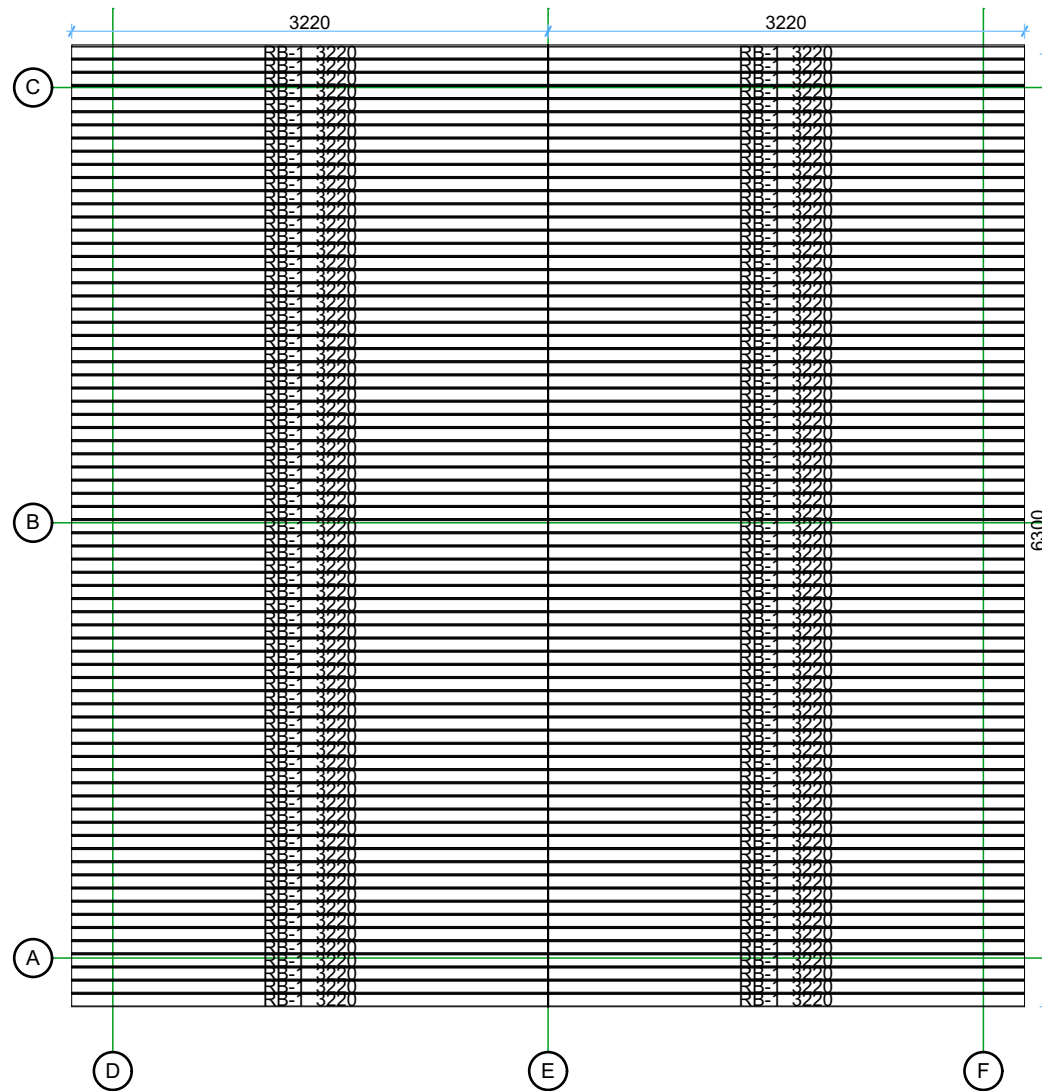

Thickness:	Project name:	Project ID:	Year:	Page:
44	Garage 6x6	v.2	2022	5

Wall A

1:50

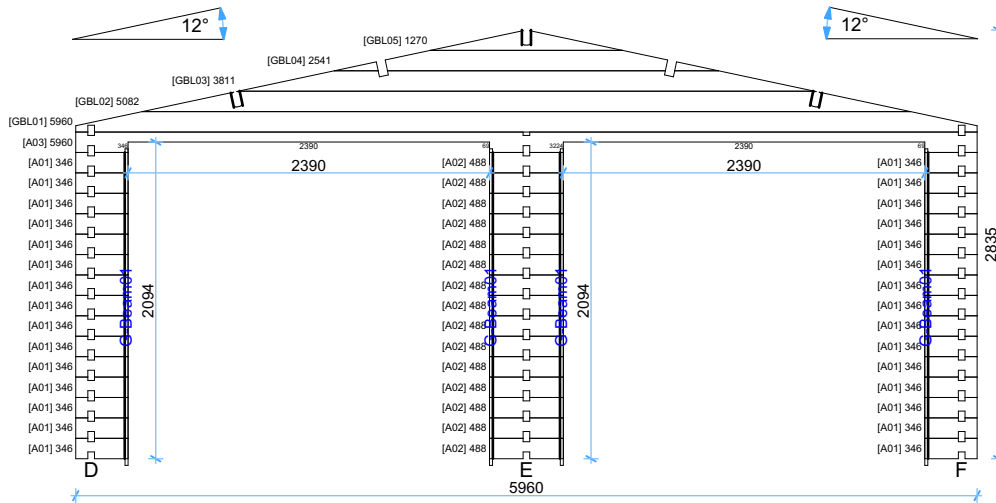

Wall B

1:50

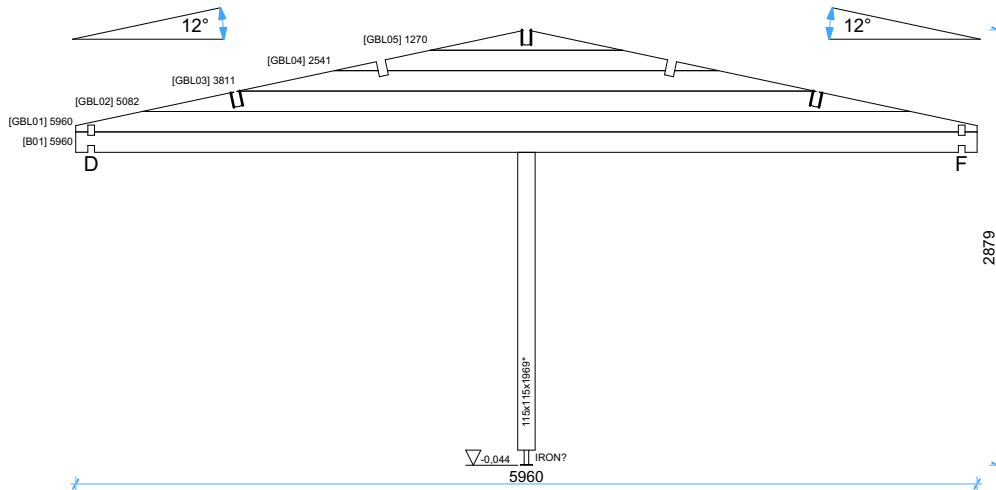

Wall C

1:50

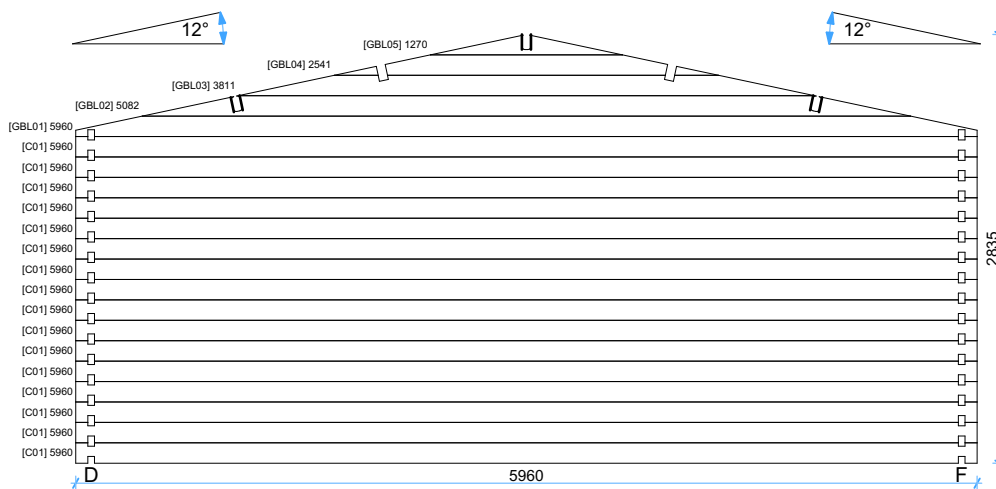

Thickness:	Project name:	Project ID:	Year:	Page:
44	Garage 6x6	v.2	2022	6

Wall D

1:50

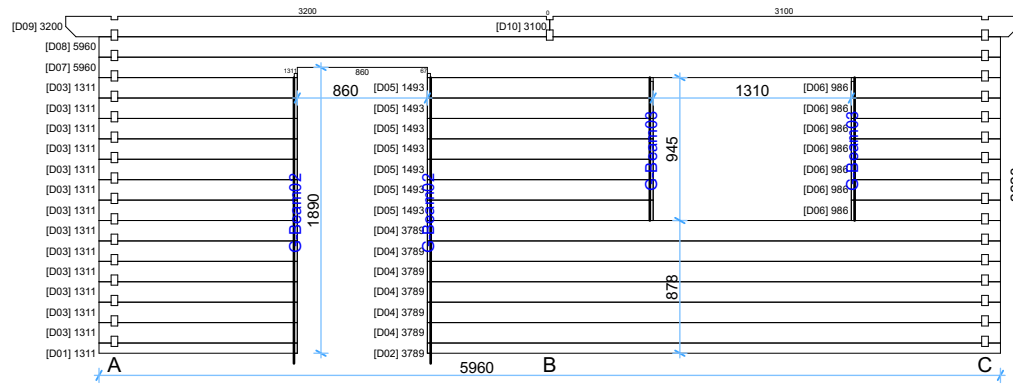

Wall E

1:50

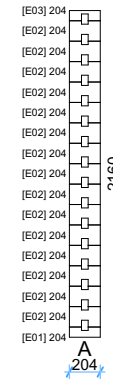

Wall F

1:50

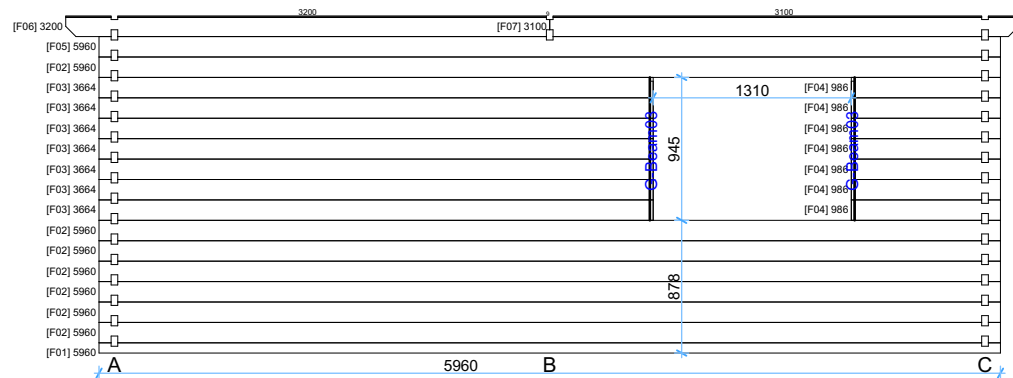

Thickness:	Project name:	Project ID:	Year:	Page:
44	Garage 6x6	v.2	2022	7

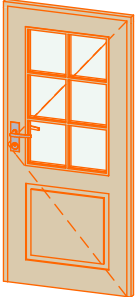
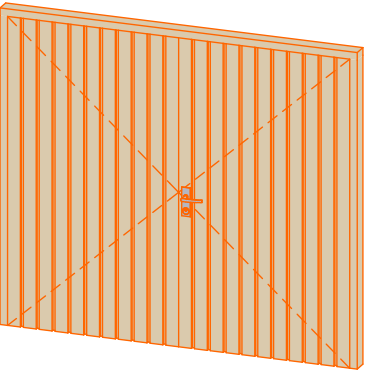
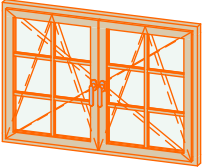
Windows and doors list							
Type-quality	Barcode	Wall Thickness	W x H Size	Orientation	Glazing	Quantity	3D Axonometry
Door - Economy	EP18585-2	44	850×1850	R	50% glass, double glazed	1	
Garage gate - Wooden	GG-WOOD	44	2380×2093	R	Full wood	2	
Window - Economy	EP92130	44	1300×920		Double glazed	2	

Thickness:	Project name:	Project ID:	Year:	Page:
44	Garage 6x6	v.2	2022	8