

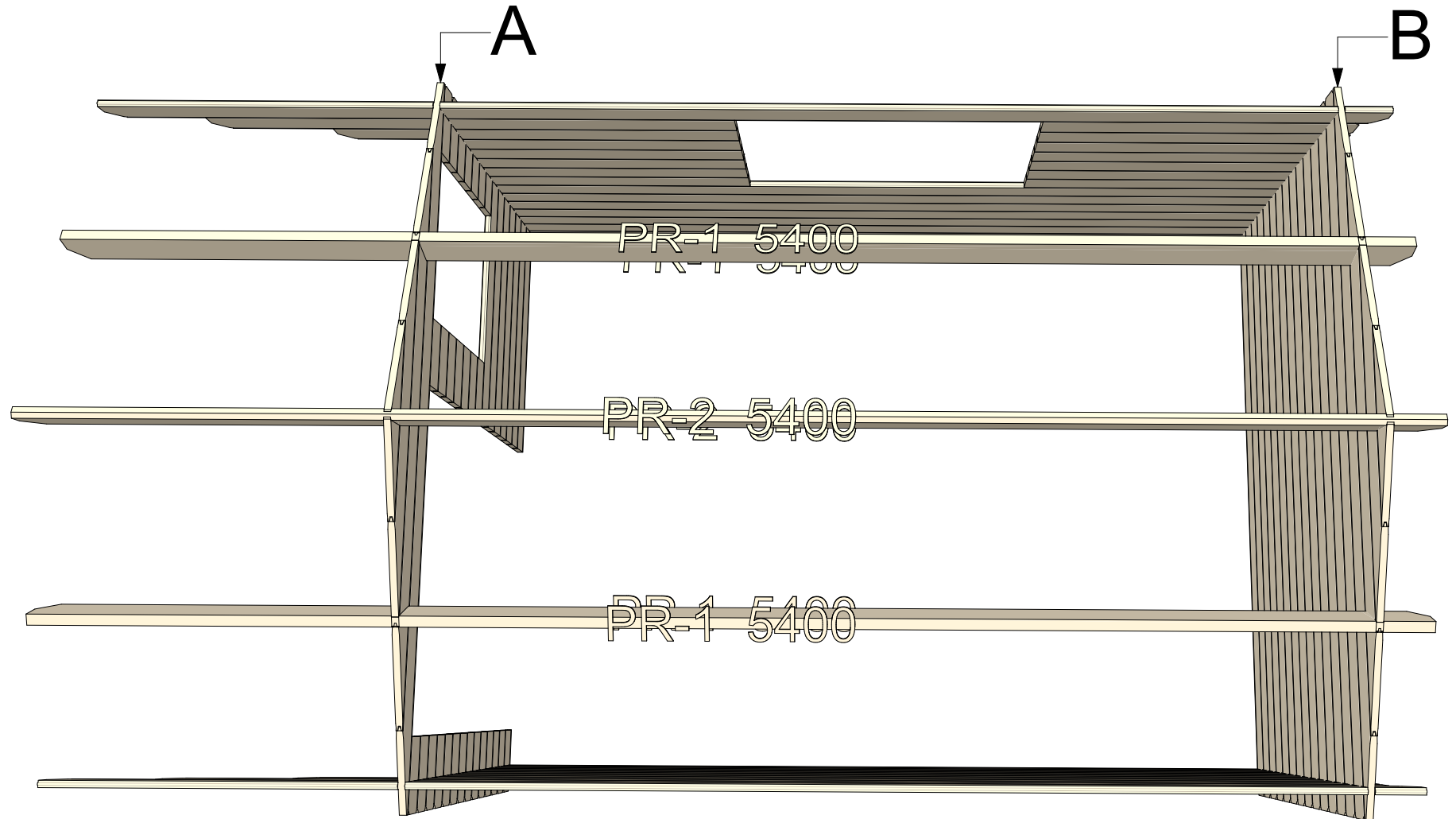

**28 Alva 3x4**

# Walls and purlins positions



Thickness:	Project name:	Project ID:	Year:	Page:
28	Alva	3x4	2024	2

Floor bearers

1:40

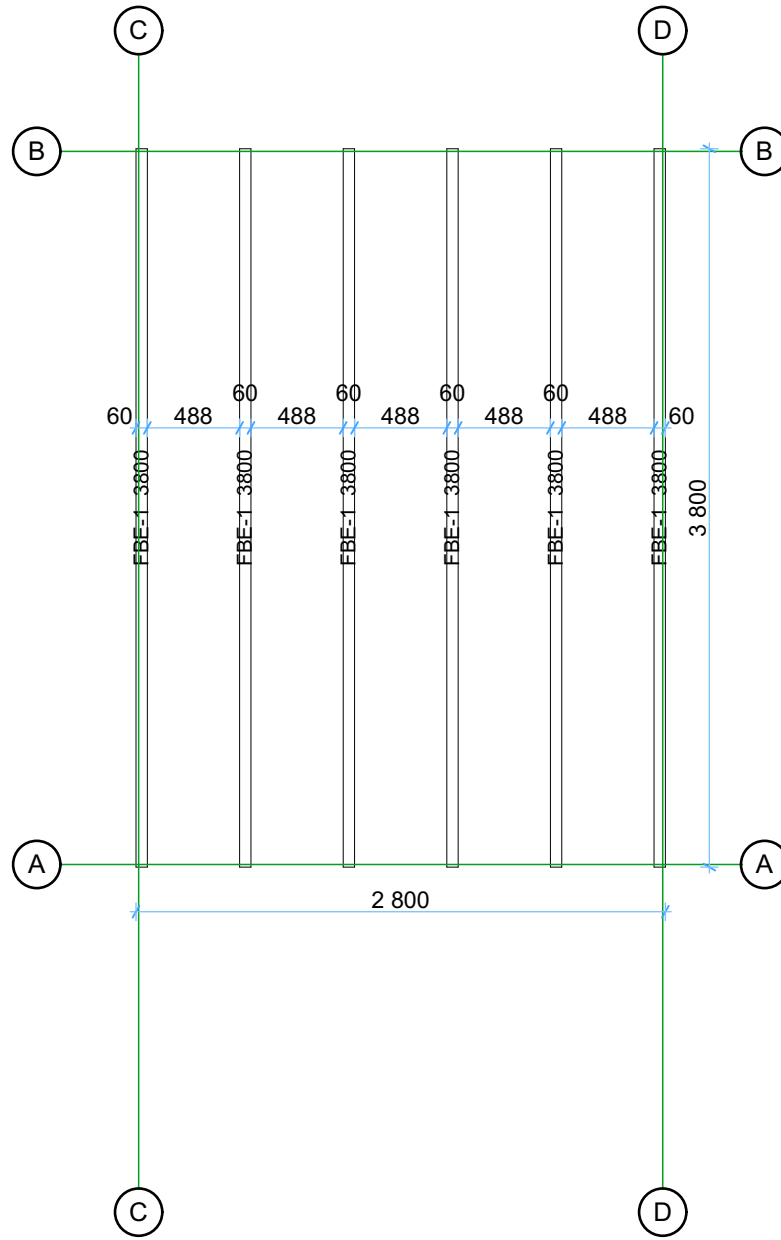

Floor boards

1:40

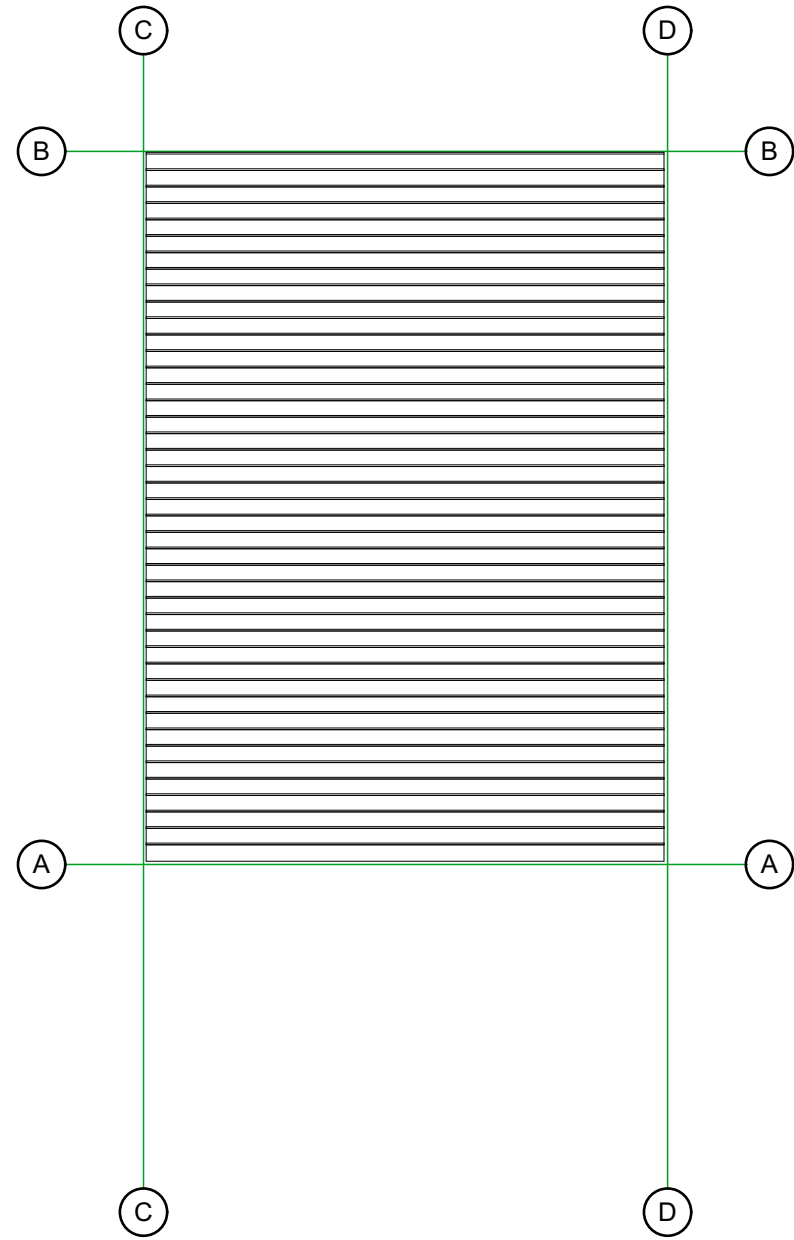

Thickness:	Project name:	Project ID:	Year:	Page:
28	Alva	3x4	2024	3

Ground floor plan

1:40

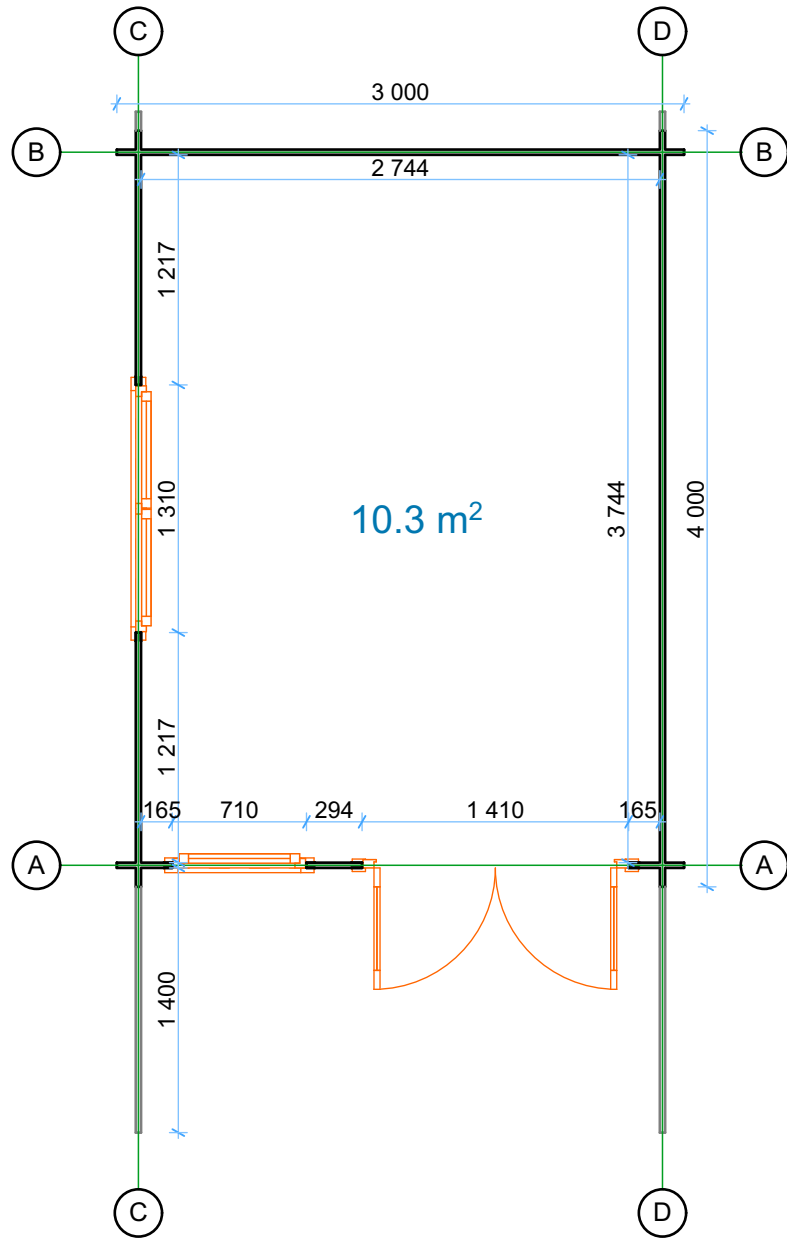

Roof boards

1:40

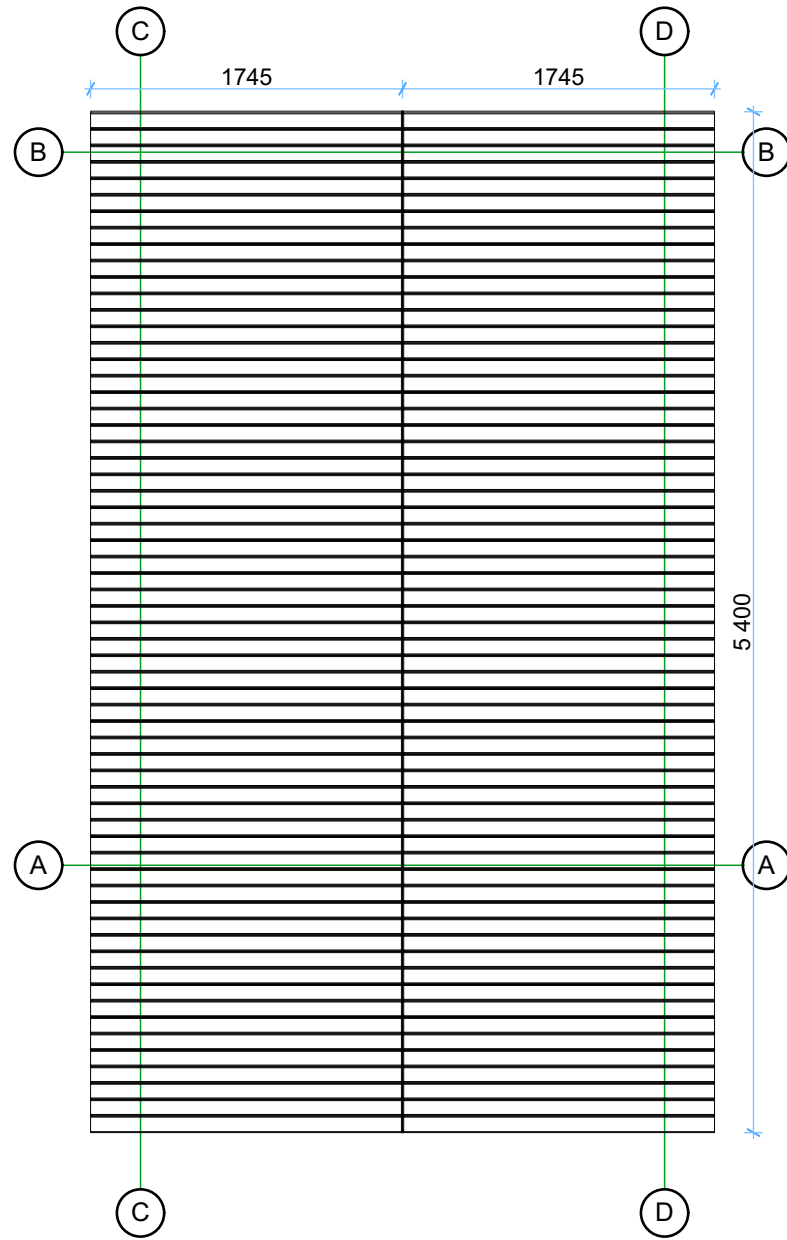

Thickness:	Project name:	Project ID:	Year:	Page:
28	Alva	3x4	2024	4

Wall A

1:40

Wall C

1:40

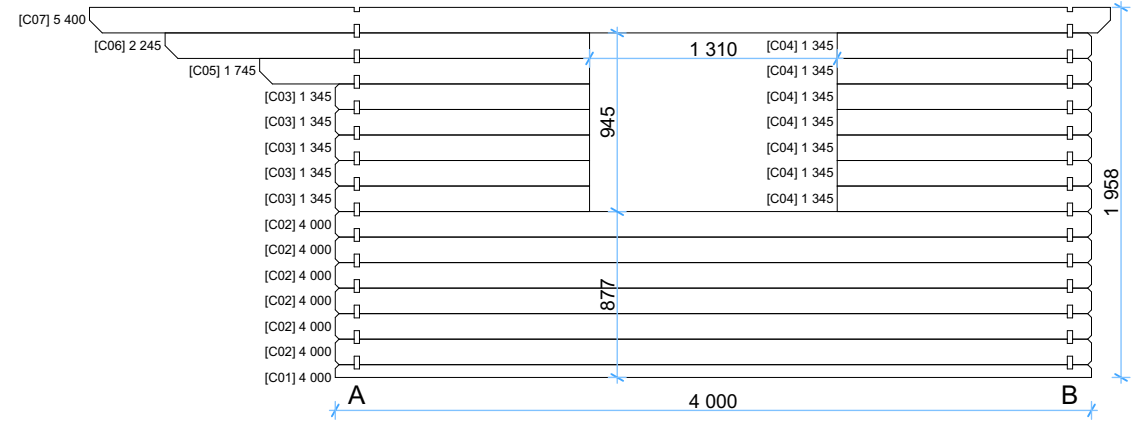
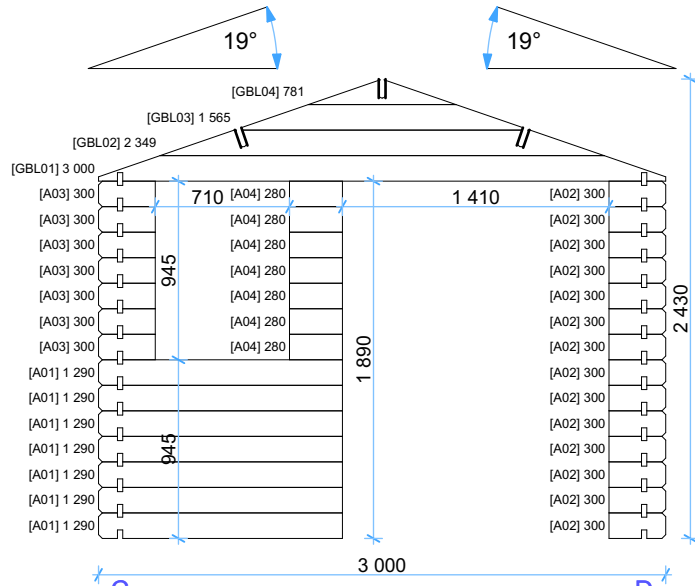

Wall B

1:40

Wall D

1:40

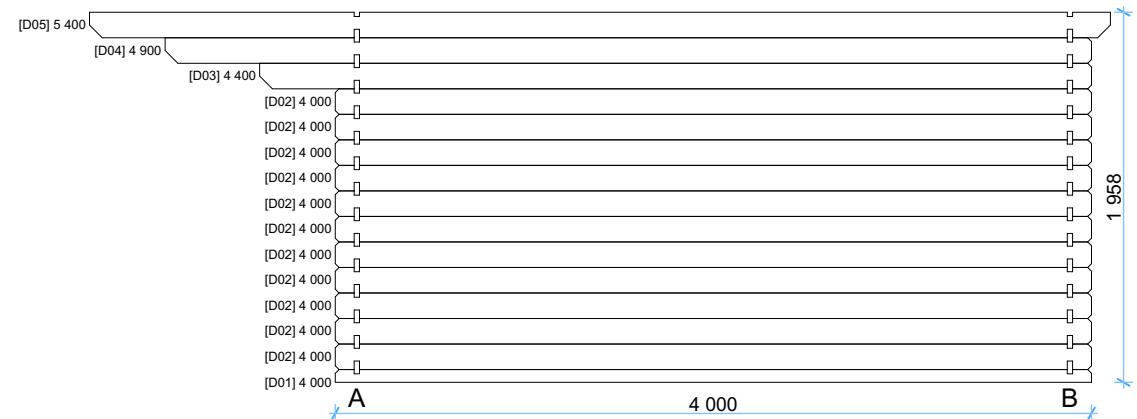
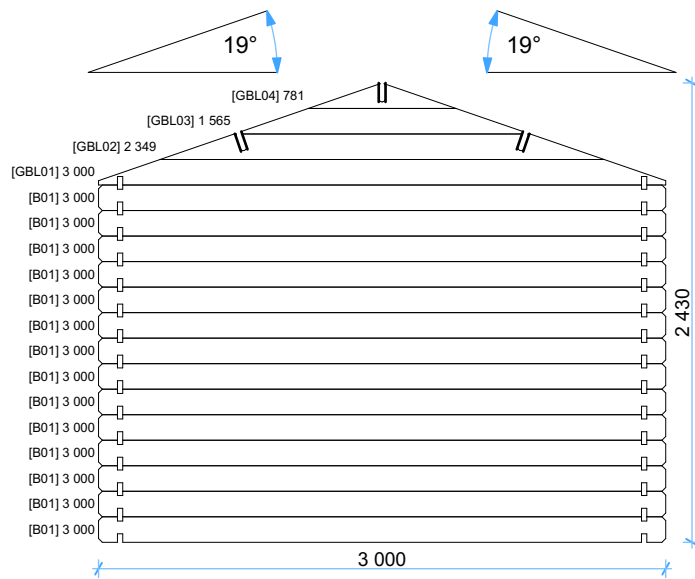

Thickness:	Project name:	Project ID:	Year:	Page:
28	Alva	3x4	2024	5

Windows and doors list							
Barcode	Type-quality	Wall Thickness	W x H Size	Orientation	Glazing	Quantity	3D Axonometry
S185140-3	Door - Economy	28	1 400×1 850	R	100% glass, single glazed	1	
S92130	Window - Economy	28	1 300×920		Single glazed	1	
S9270	Window - Economy	28	700×920	R	Single glazed	1	

Thickness:	Project name:	Project ID:	Year:	Page:
28	Alva	3x4	2024	6